

CELSIUS™

SOLID ROOF



Installation guide

Step-by-step instructions

Contents

Tools Required to Install Solid Roof	p1
Screws & Fixings	p2
Injection Moulded Solid Components	p3
Components	p4
Georgian Hips & Ancillaries	p5
Fixing Eaves Beam Timber to Frames	p6 - 7
Setting Wall Starter Timber	p8
Marking Panels for Fixing Locations	p9
Roof Panel Fixed to Wall	p10 - 11
Fitting Ridge	p12
Assembly Sequences	
Georgian Style Roof	p13
Victorian Style Roof	p14
Lean-To Style Roof	p15
Roof Panel Assembly	p16 - 17
Hip Assembly	p18 - 19
Fixing Roof Panel to Eaves Infill Timber	p20
180mm Fixings	p21
Fitting Eaves Tray	p22
Fitting Breather Membrane	p23 - 24
Fitting Starter Soaker	p25
Fitting Eaves Tile Bar	p26 - 27
Tiling	p28 - 35
Hip Caps	p36 - 37
Ridge Caps	p38 - 39
Fascia Board	p40 - 42
Tie Wires	p43 - 46
VELUX Window	p47 - 49
Gable End	p50 - 59
Gutter	p60
Changelog	p61

Tools Required To Install Solid Roof

IMPORTANT: It is the installer's responsibility to make sure the correct access safety equipment is used during the installation of the Celsius Solid Roof, such as access ladders and scaffolding.



Hand Saw



Cordless Drill



Tape Measure



Mallet (Soft Face)



Spirit Level



Utility Knife



Staple Gun (Industrial)



Pencil / Marker



6mm Drill Bit

Screws & Fixings

6mm x 180mm
fixings (50's)
XSR-CSS6180 - 50

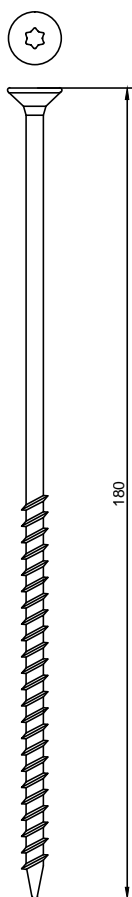

6mm x 140mm
fixings (50's)
XSR-CSS6140 - 50

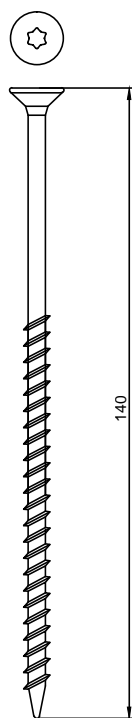

4.5mm x 40mm
fixings (200's)
XSR-SS440 - 200

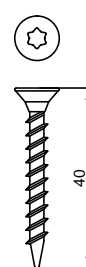

T30 Torx Bit
T20 Torx Bit

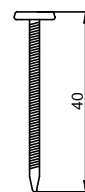

40mm Polypins (250's)
XSR-FBF1 - 250

Injection Moulded Solid Roof Components

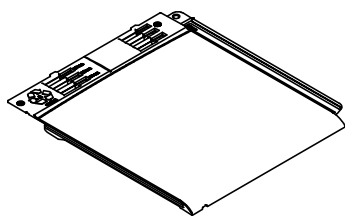

Single Tile
XSR-RTS1

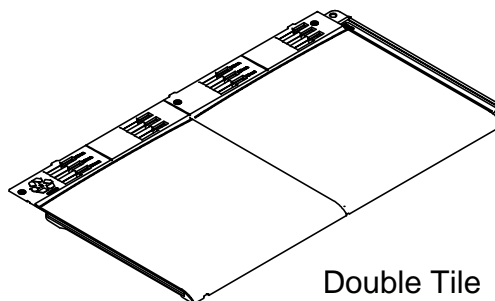

Double Tile
XSR-RTD1

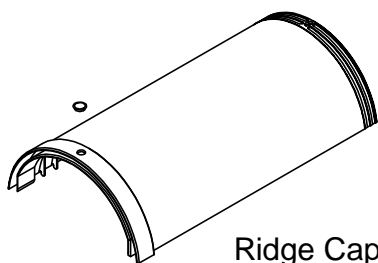

Ridge Cap
XSR-RC1
Screw Cover Cap
XSR-SCC1 (x1)

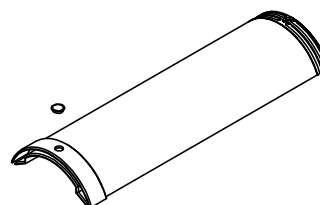

Hip Cap
XSR-HC1
Screw Cover Cap
XSR-SCC1 (x1)

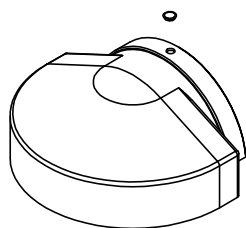

Ridge To Apex Cover
XSR-RHA1
Screw Cap Cover
XSR-SCC1 (X1)



Hip End Cap
XSR-HEC1
Screw Cap Cover
XSR-SCC1 (X1)

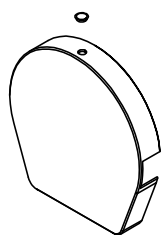

Gable End Cap
XSR-GEC1
Screw Cover Cap
XSR-SCC1 (x1)

Components

Starter Soaker
XSR-SS1

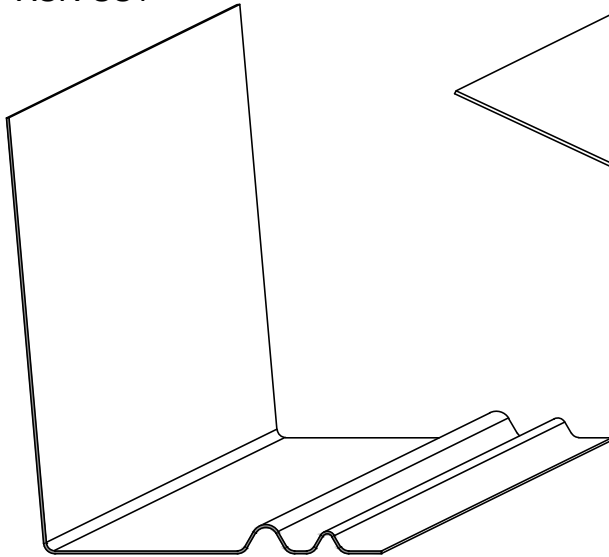

Eaves Tray

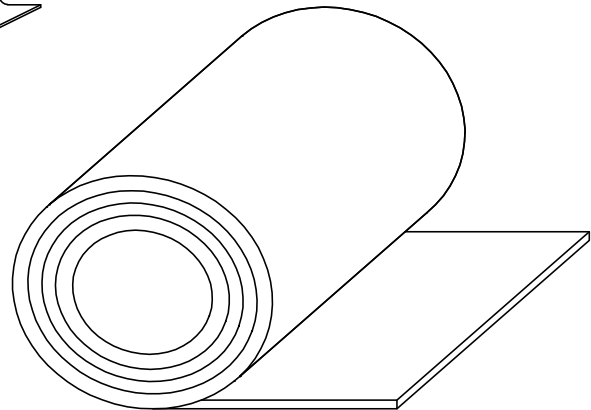
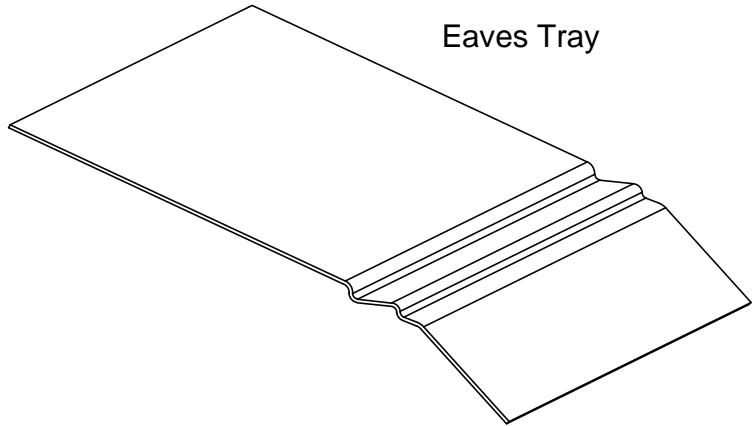

Breather Membrane 150mm
XSR-BM1

Dry Verge
XSR-DV1

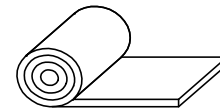
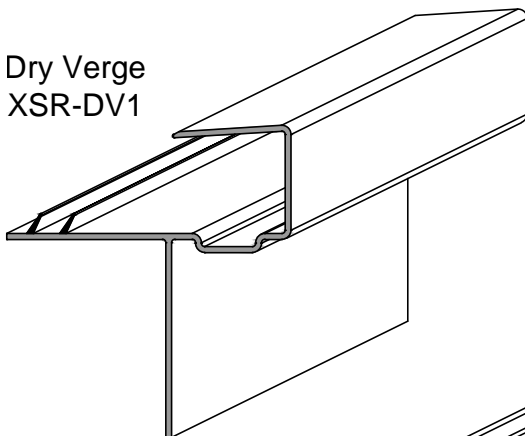

Expanding Foam
20mm x 25mm 5.6m Long

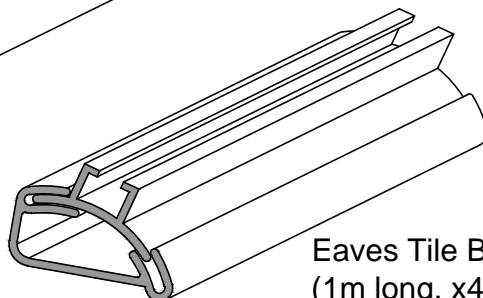

Eaves Tile Bar
(1m long, x4 Fixings per length)
XSR-ETB1

Georgian Hips

Georgian hip to suit

Roof Pitch	Angle X
20°	152°
25°	145°
30°	139°
35°	132°

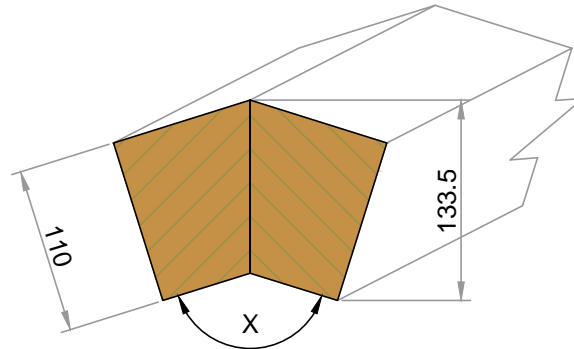

Ancillaries

Wall Starter Timber

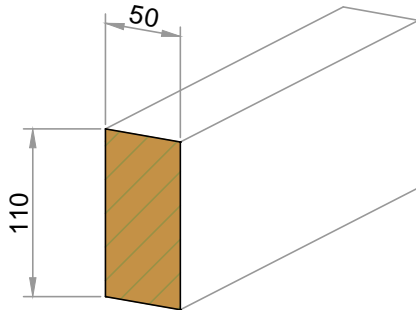

Butt Joint Timber

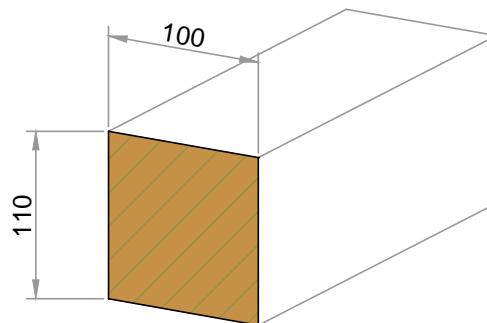

Butt Joint Cassette

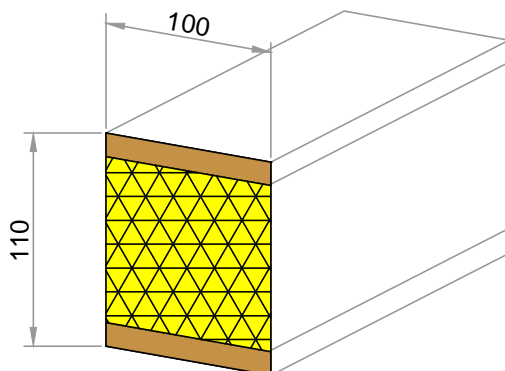

Eaves Beam Timber
XSR-E25

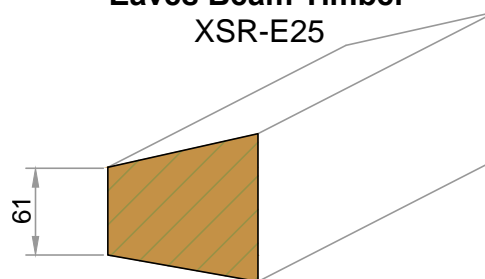

See pages 6-8
for eaves beam pitch
and dimensions

All Dimensions In mm

Fixing Eaves Beam Timber To Frames

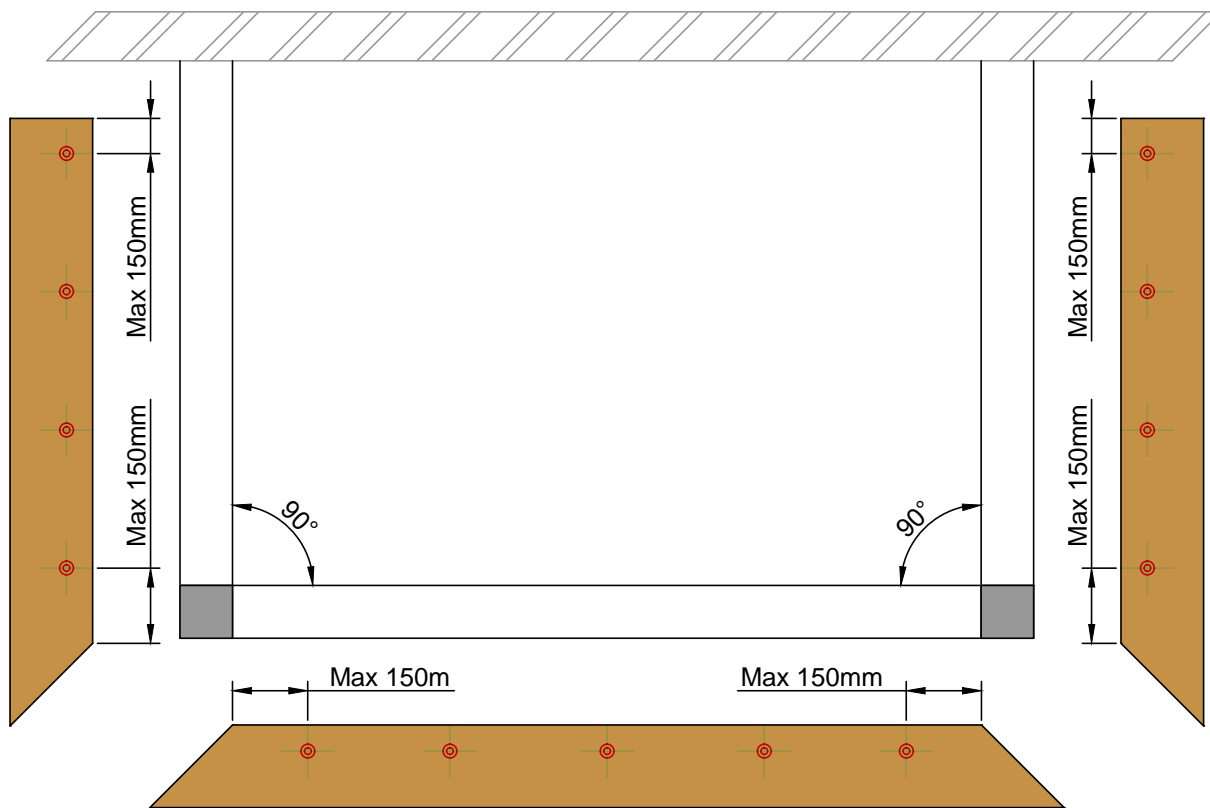

Secure timber eaves beam section to frames using the supplied XSR-CSS6140 6mm x 140mm screws at maximum 500 centres. Recommended fixing up through frame into timber. Screw should engage into timber by approx 45mm.

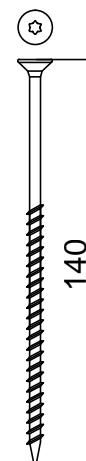
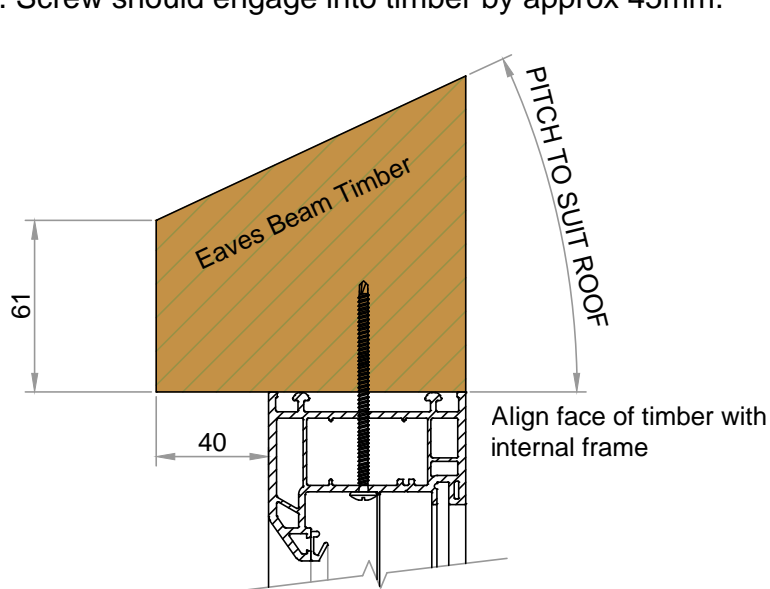

XSR-CSS6140 - 50
6mm x 140mm
fixings (50's)

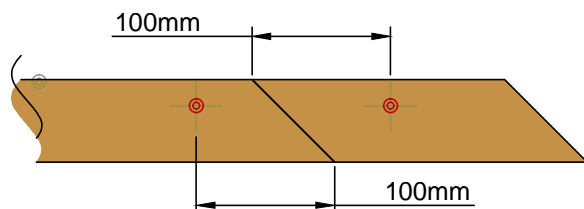

Where timbers longer than 6m are required they must be joined at a 45° cut and fixed to the frame using fixing screws 100mm either side of the joint.

Fixing Eaves Beam Timber To Frames

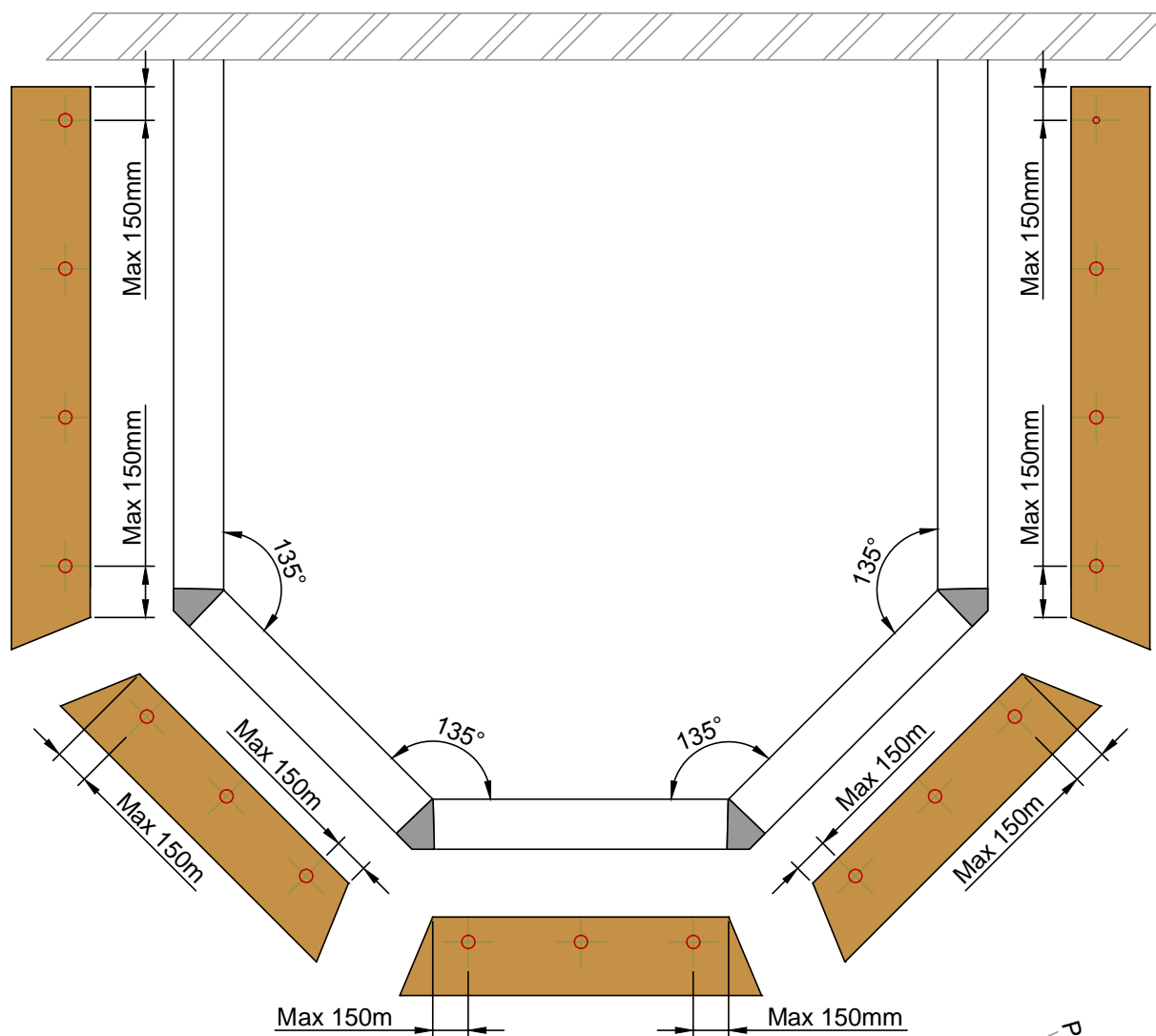

Secure timber eaves beam section to frames using appropriate screws to suit outer frame height at maximum 500 centres. Recommended fixing up through frame into timber. Screw should engage into timber by approx 45mm.

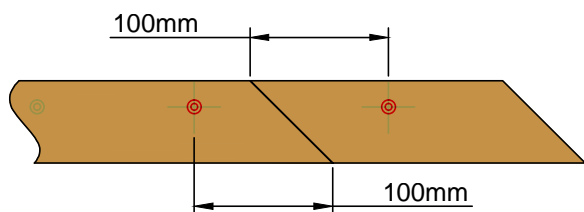
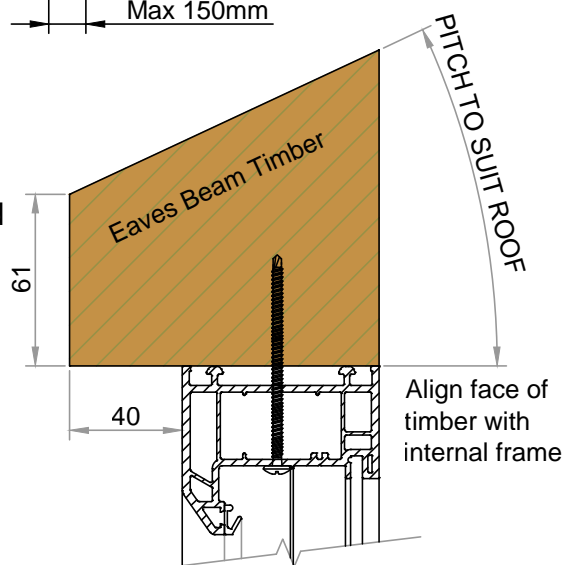

Where timbers longer than 6m are required they must be joined at a 45° cut and fixed to the frame using fixing screws 100mm either side of the join.

Setting Wall Starter Timber

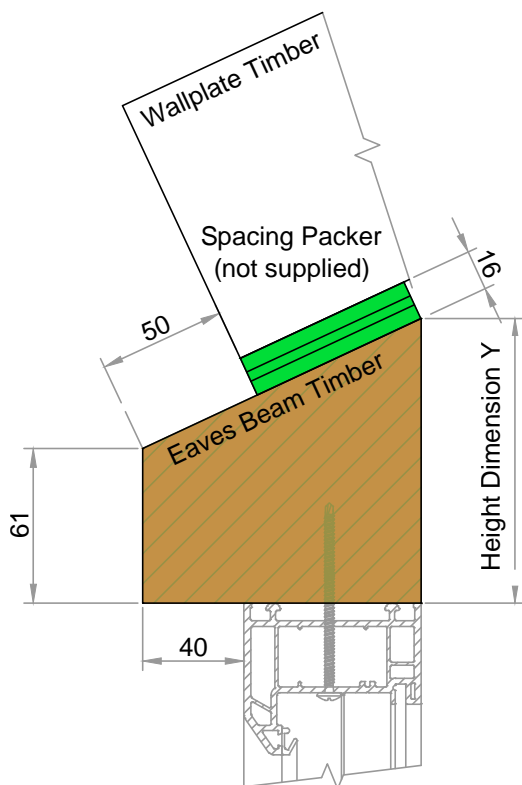

Roof Pitch	Height Dimension X
12.5 Degrees	307.5mm
15 Degrees	358.5mm
20 Degrees	465mm
25 Degrees	578.5mm
30 Degrees	701.5mm
35 Degrees	838mm

Roof Pitch	Height Dimension Y
12.5 Degrees	85.5mm
15 Degrees	90.5mm
20 Degrees	101mm
25 Degrees	112.5mm
30 Degrees	124.5mm
35 Degrees	138mm

Set wall starter position over eaves beam timber as shown. Ensure that a 16mm gap is left between the top of the eaves beam and the underside of the timber wall starter, and the end of the timber is 50mm clear from the edge of the eaves beam as shown above. The same applies for the starter timber on the opposite side, and the two timbers should come together at the roof centreline. Use above table to check correct roof pitch.

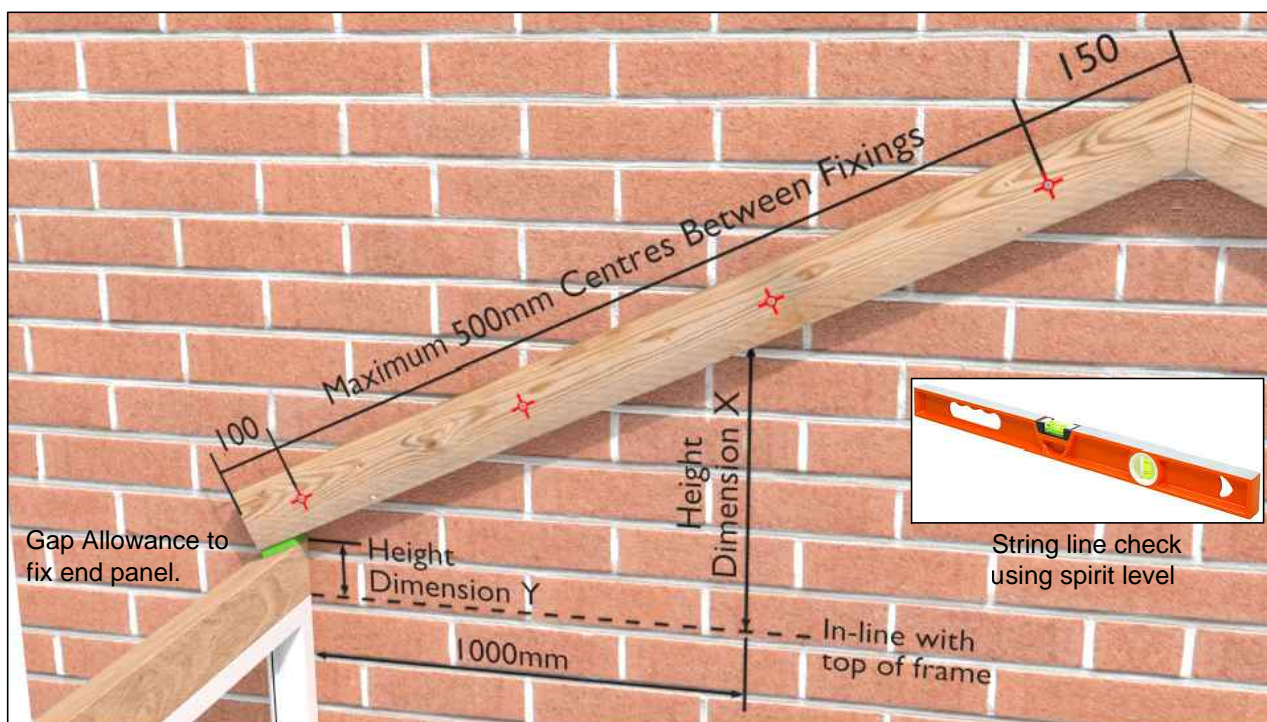

Marking Panels For Fixing Locations

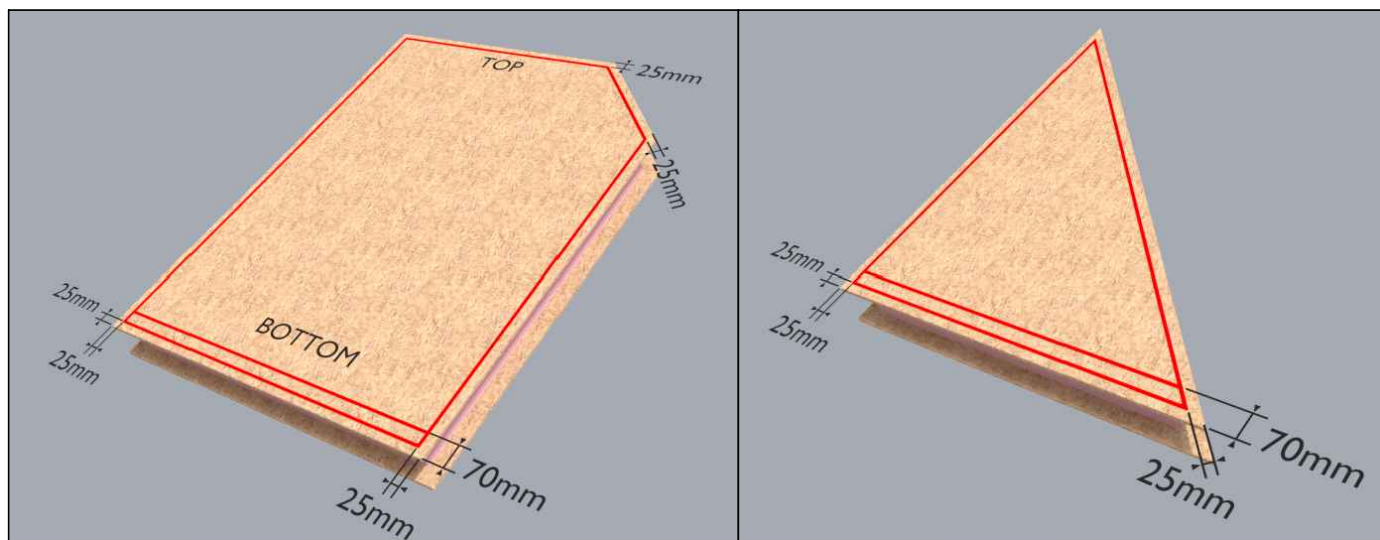

Mark all panels 25mm from all outer edges using either a pencil or marker pen.

Mark an additional line 70mm from edge at bottom of panel only.

Repeat process on under side of panel.

NOTE: There is no need to mark the 25mm or 70mm lines at the bottom edge on the under side of the panels (see below).

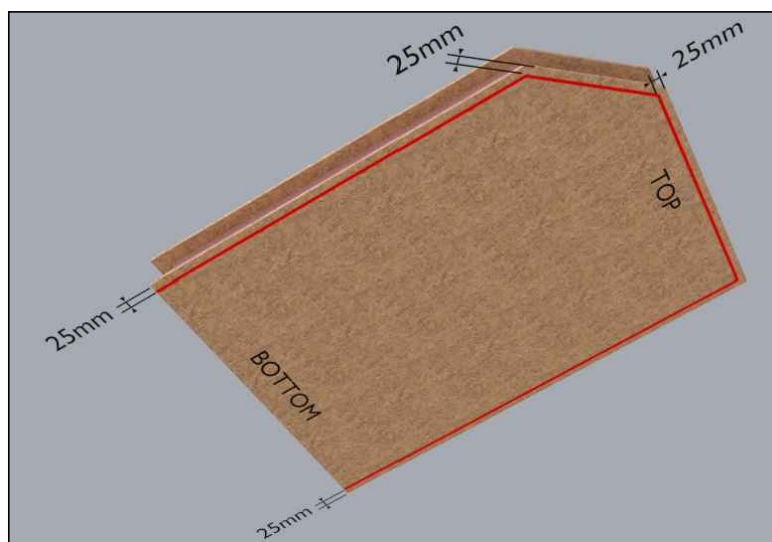

IMPORTANT: It is the installer's responsibility to make sure the correct access safety equipment is used during the installation of the Celsius Solid Roof, such as access ladders and scaffolding.

Roof Panel Fixed To Wall

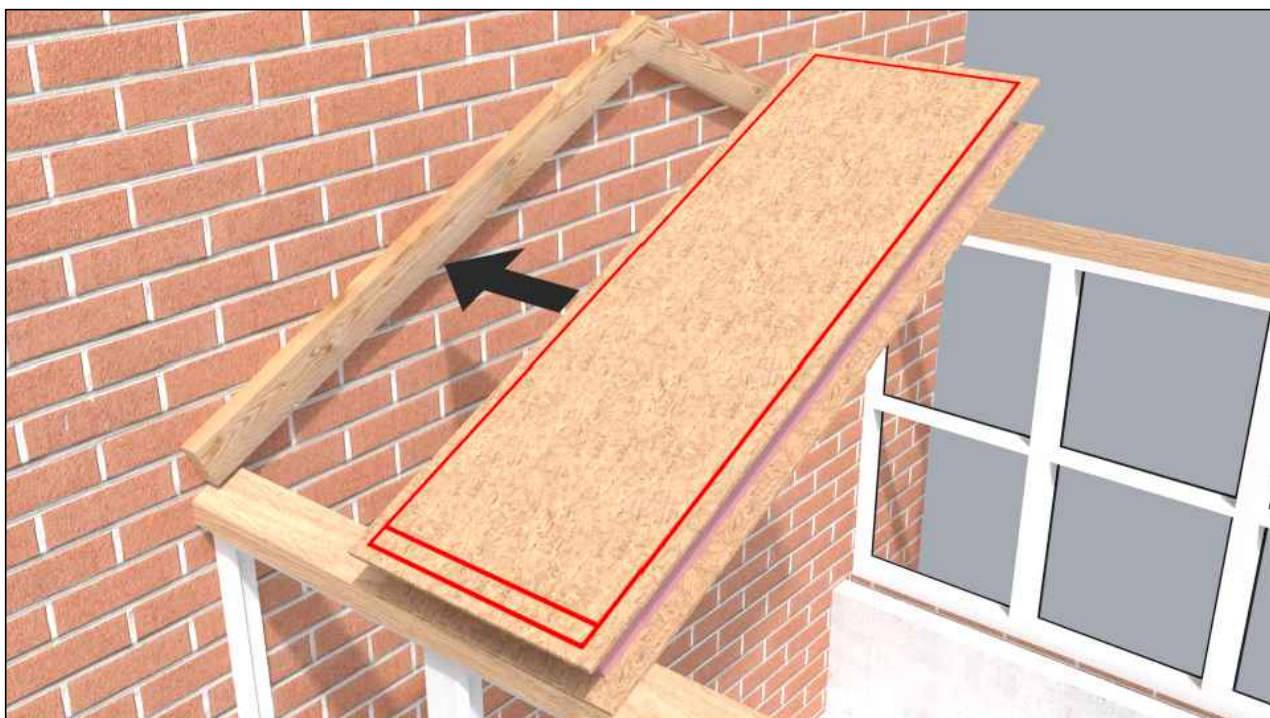

Insert first roof panel over wall starter timber and resting onto eaves beam timber. Ensure that the panel is fully located and pushed up to the host wall. Secure into position using 40mm screws as shown below, making sure bottom of panel is flush with outside face of eaves beam timber.

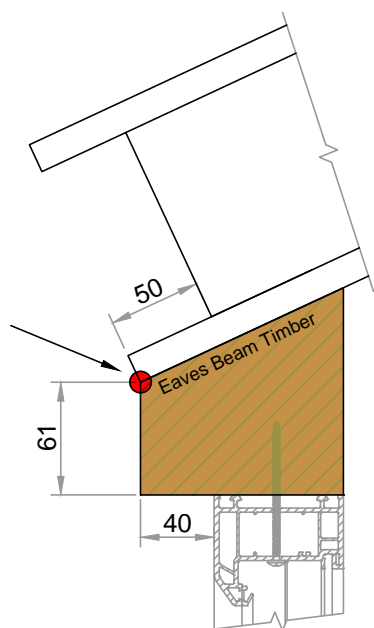

Ensure bottom edge of panel is in line with front face of eaves beam timber

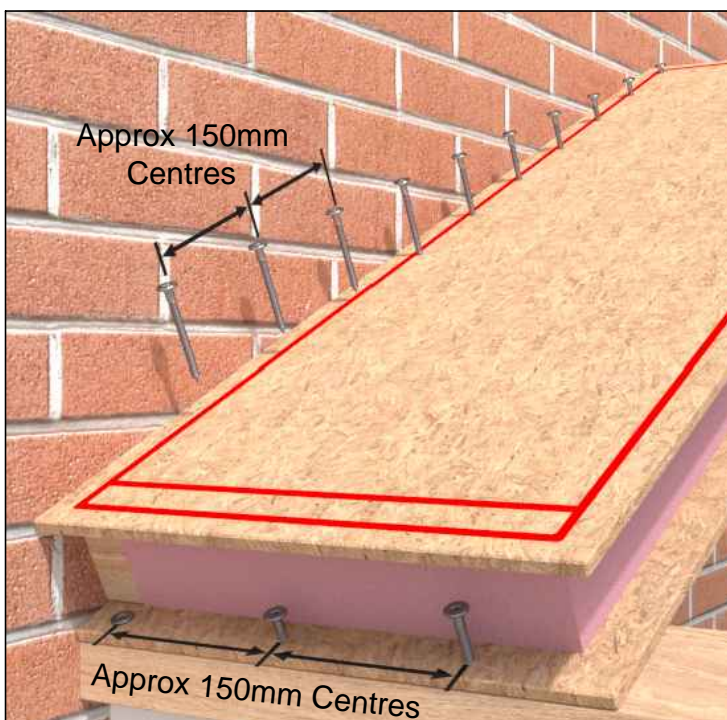

40mm screws:

Used around entire perimeter of each panel 25mm from the edge on the top & sides of the panel. Bottom fixings to be as indicated in detail. (see page 22)

Roof Panel Fixed To Wall

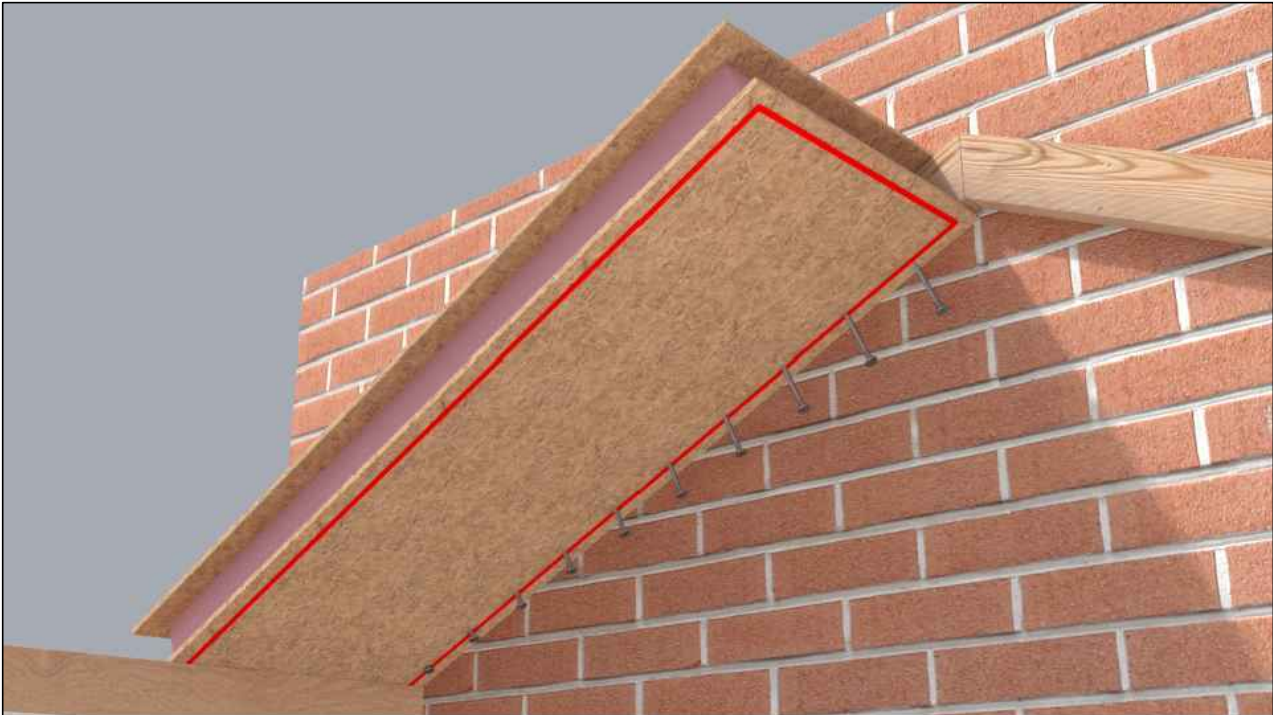

Repeat fixing using 40mm screws on underside of panel to secure panel to wall starter timber.

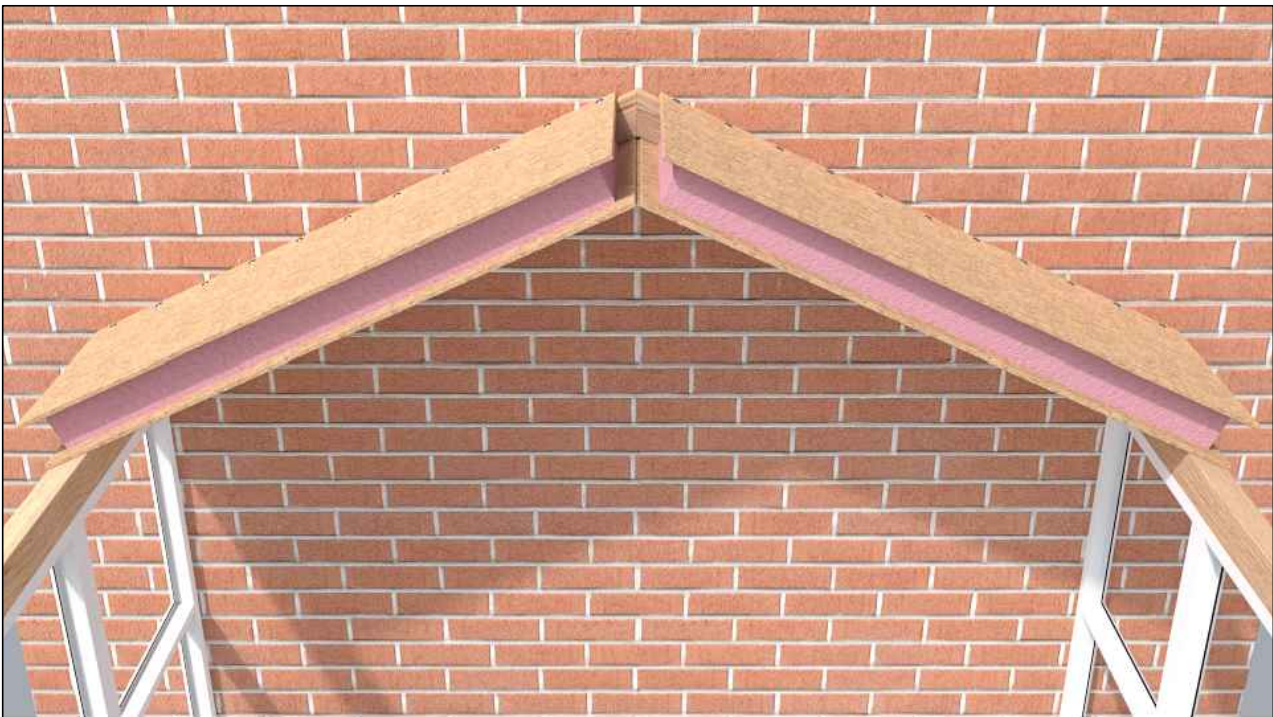

Repeat process for wall panel on opposite side of roof using 40mm screws as directed.

Fitting Ridge

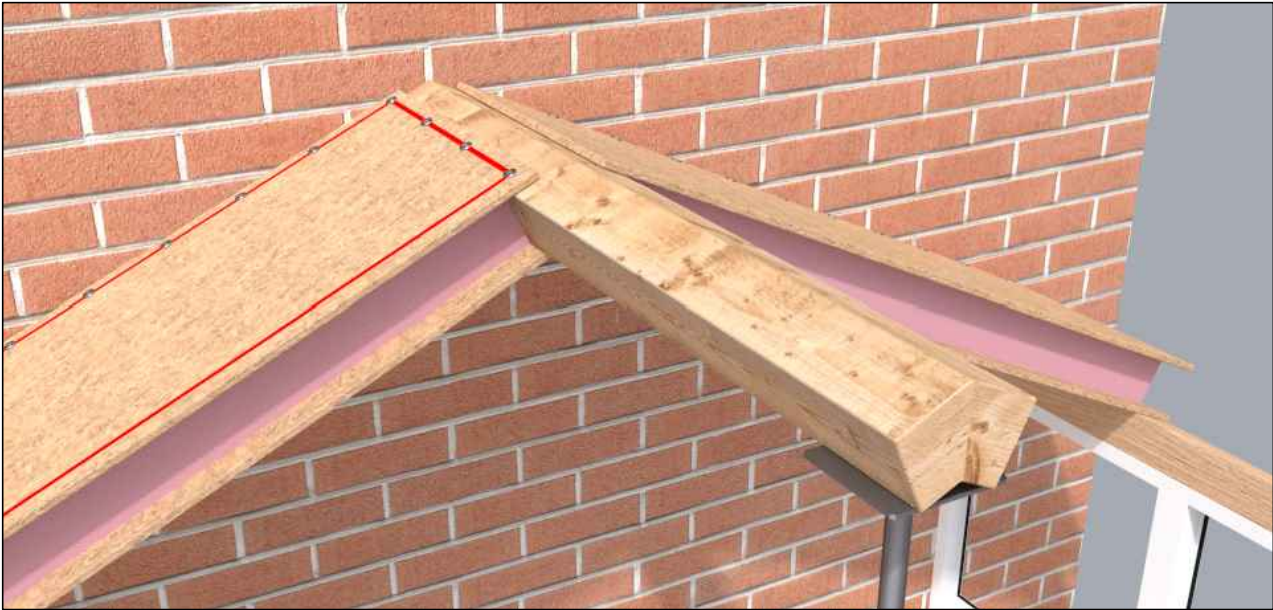

Insert ridge timber between wall panels and butt up to wall timbers. Fix using 40mm screws at approx. 150mm centres as shown below. Support ridge end as required.

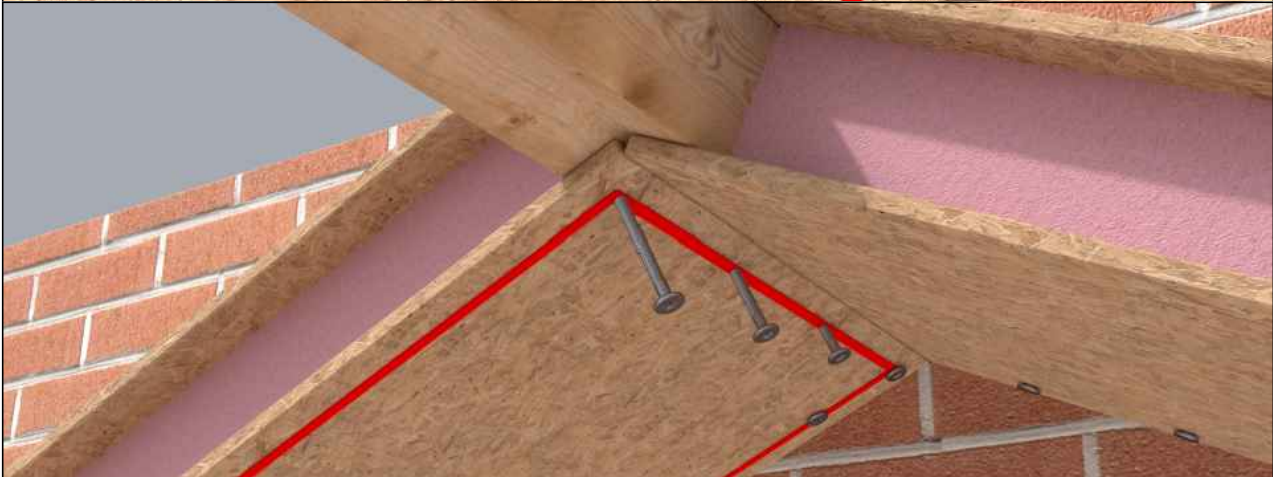
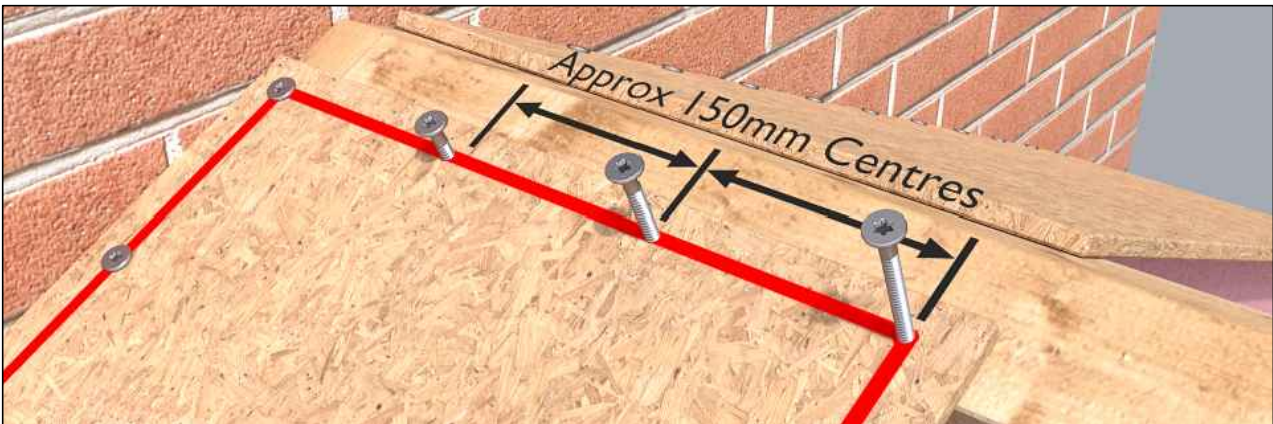

Georgian Style Roof Assembly Sequence

Georgian Style Roof
Recommended Sequence To
Assemble Solid Roof Panels.

①

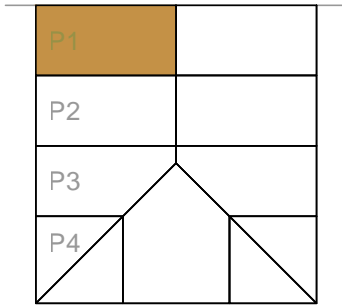

②

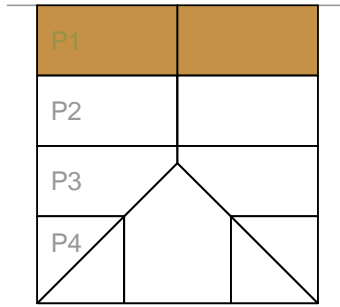

③

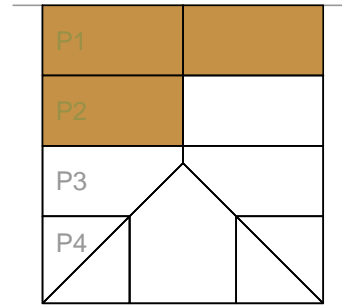

④

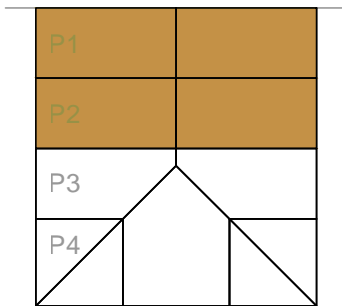

⑤

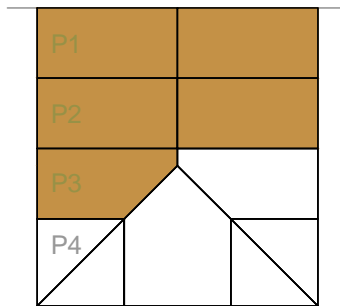

⑥

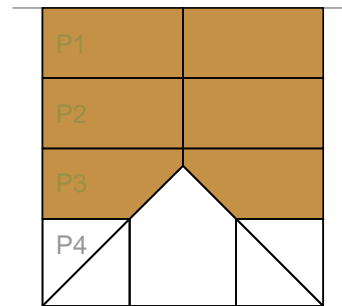

⑦

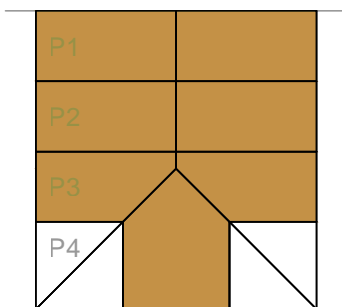

⑧

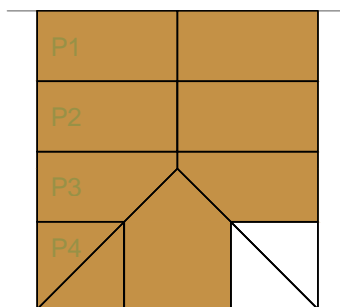

⑨

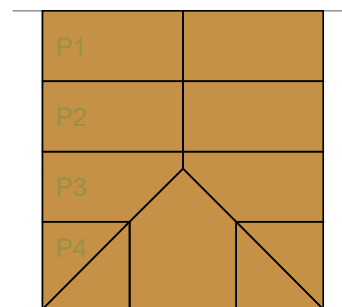

Victorian Style Roof Assembly Sequence

Victorian Style Roof
Recommended Sequence To
Assemble Solid Roof Panels.

①

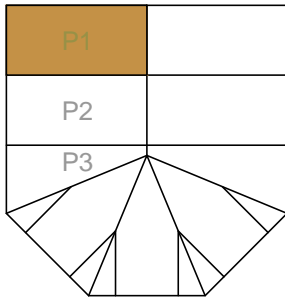

P1

②

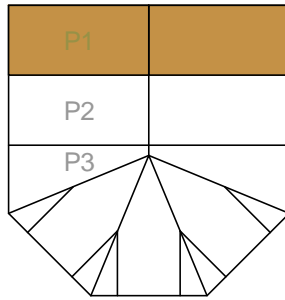

③

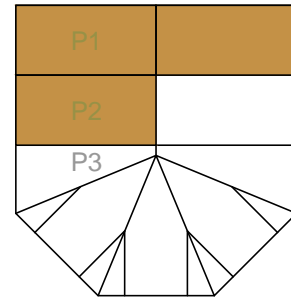

④

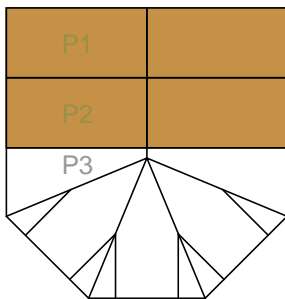

⑤

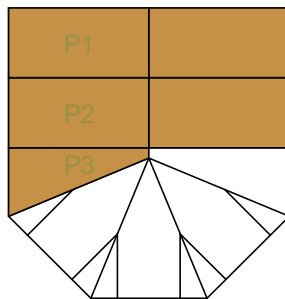

⑥

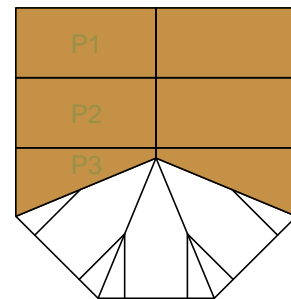

⑦

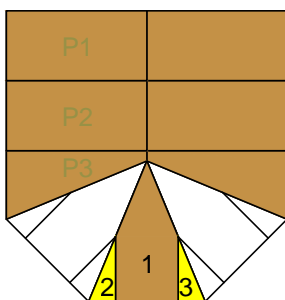

⑧

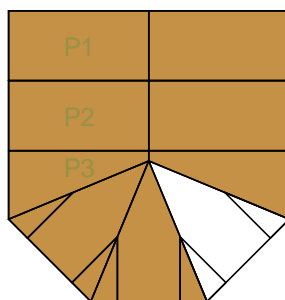

⑨

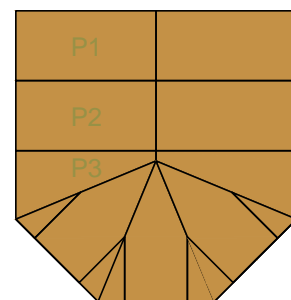

Lean-To Style Roof Assembly Sequence

Lean-To Style Roof
Recommended Sequence To Assemble Solid
Roof Panels.

①

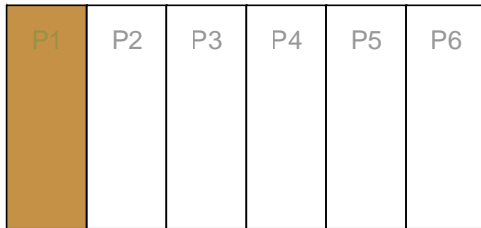

②

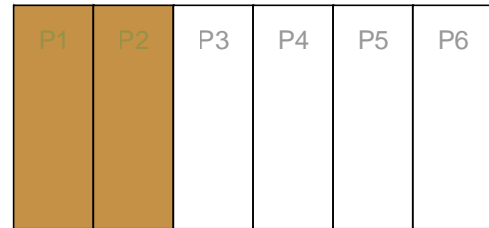

③

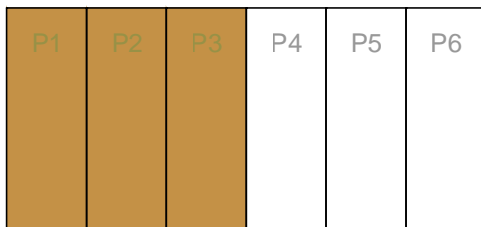

④

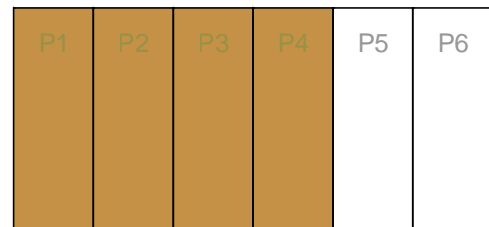

⑤

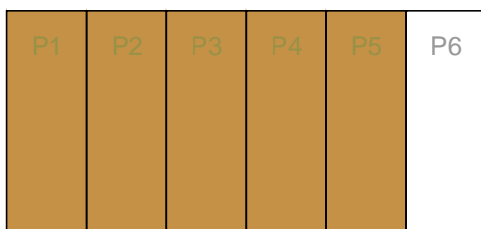

⑥

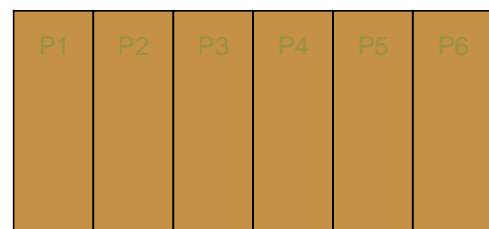

Roof Panel Assembly Method

Insert butt joint cassette into first panel and fix using 40mm screws at 300mm centres. Please note connecting timber could be either solid or connecting type - refer to supplied roof plan for connecting timber locations.

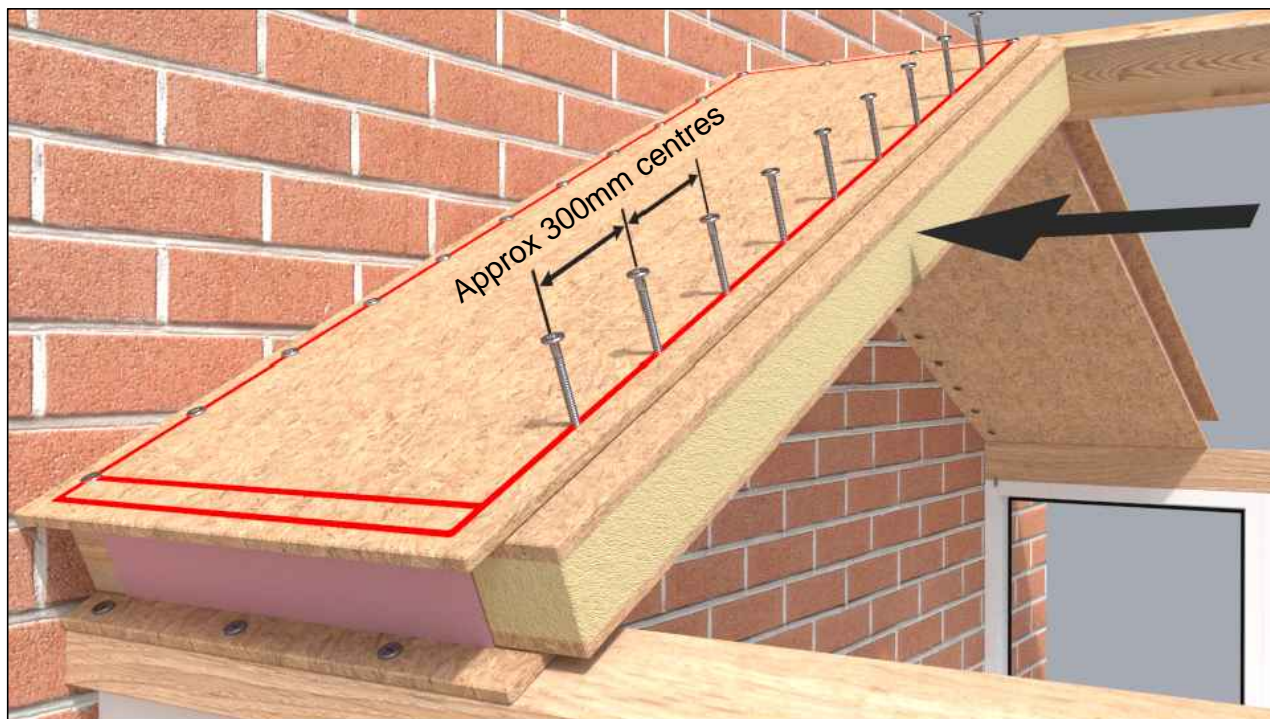

NOTE:
Fixing spacings are 150mm into solid timbers and 300mm into butt joint cassettes

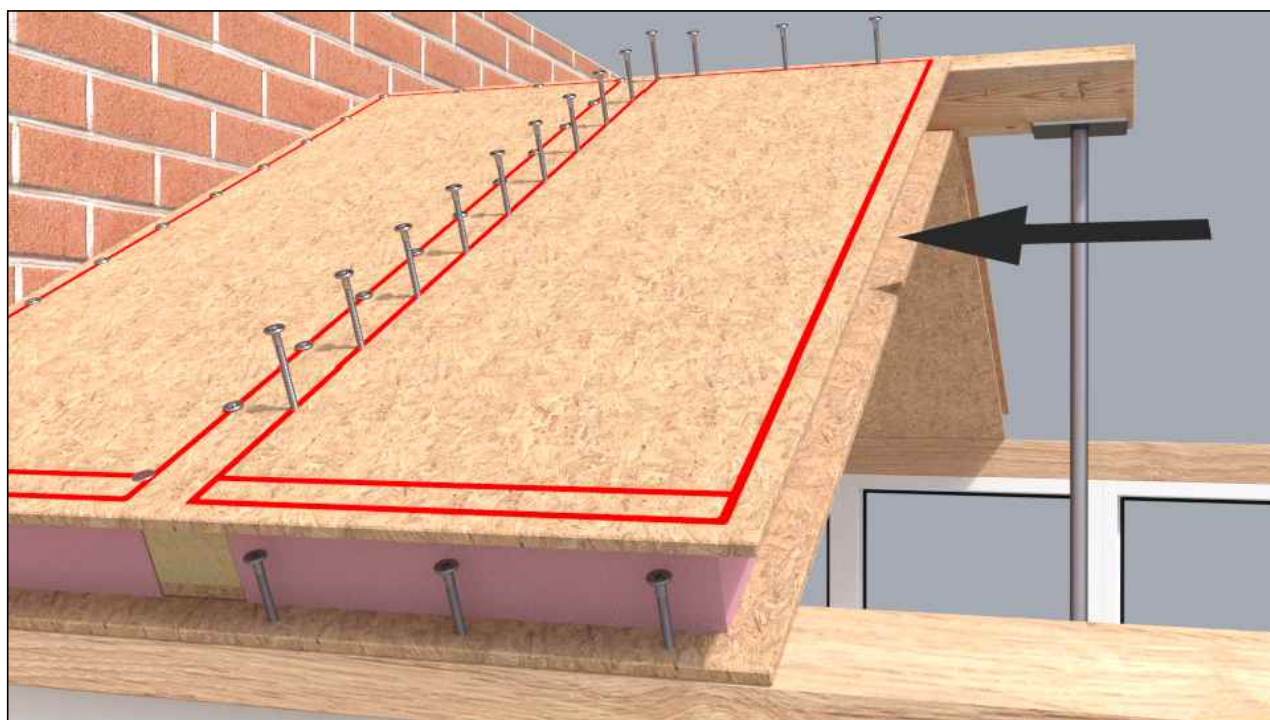

Roof Panel Assembly Method

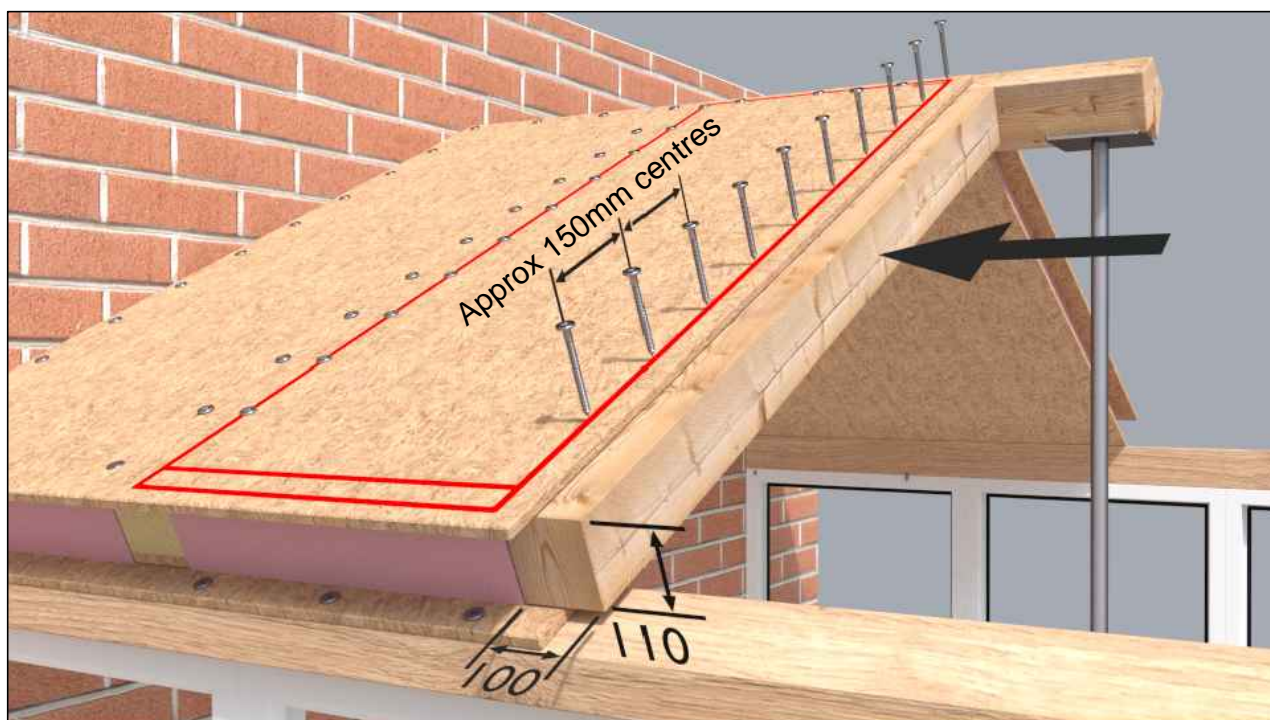

NOTE

If roof is to have a tie wire then the butt joint cassette is replaced by butt joint solid timber at the point where the tie wire is located.

Secure end panel into position using 40mm screws as per previous instructions.

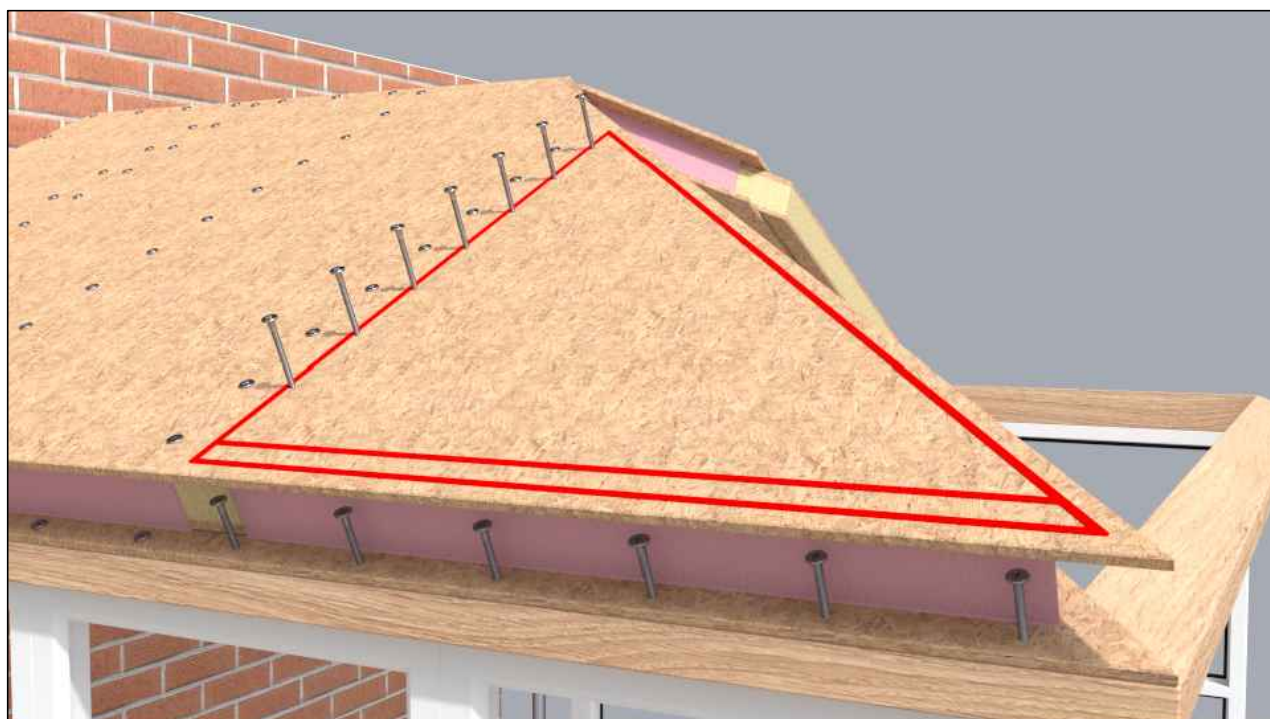

Hip Assembly Method

Insert Georgian hip rafter into position and fix to panels using 40mm screws both on top and underneath the panel. Fix at approx 150mm centres.



NOTE: Hip is marked with a 'T' and 'B' for top and bottom.



Fix using 40mm screws at 150mm centres.

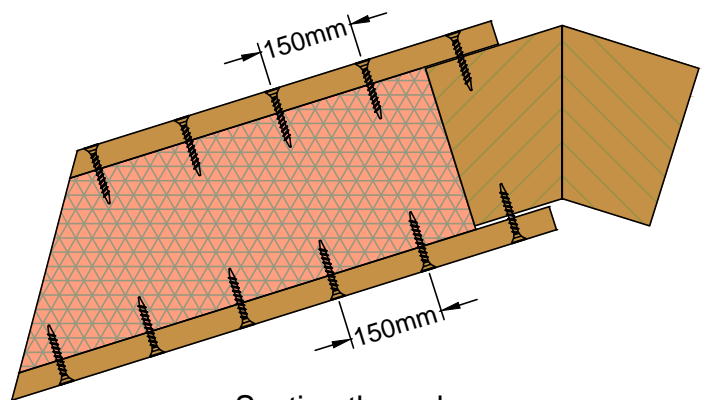

Section through Georgian hip rafter

Hip Assembly Method

Repeat process for opposite hip.

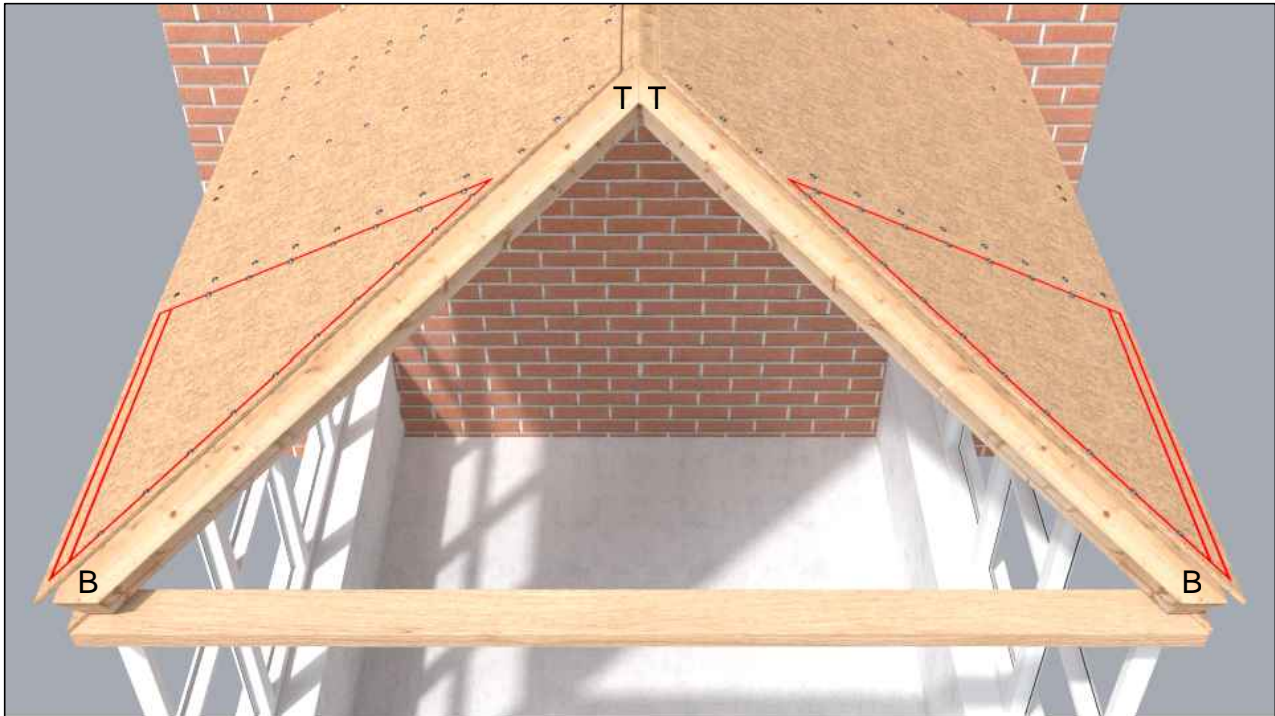

Fit remaining front panels and joint timbers / cassettes using 40mm screws on top and underneath the panels as before.

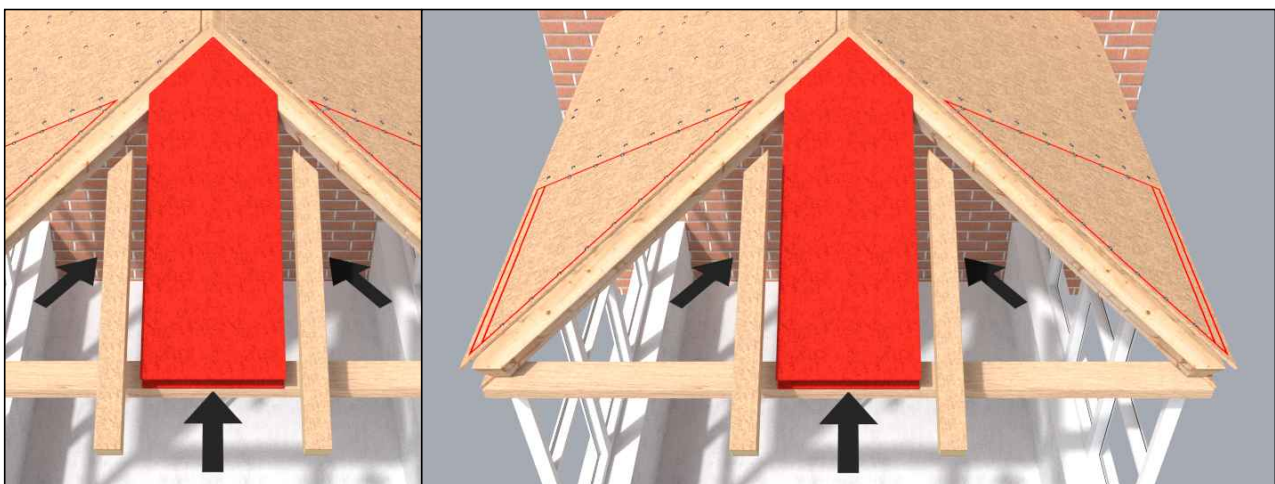

Fixing Roof Panel To Eaves Infill Timber

Insert eaves infill timber into position and ensure that timber is fully located.

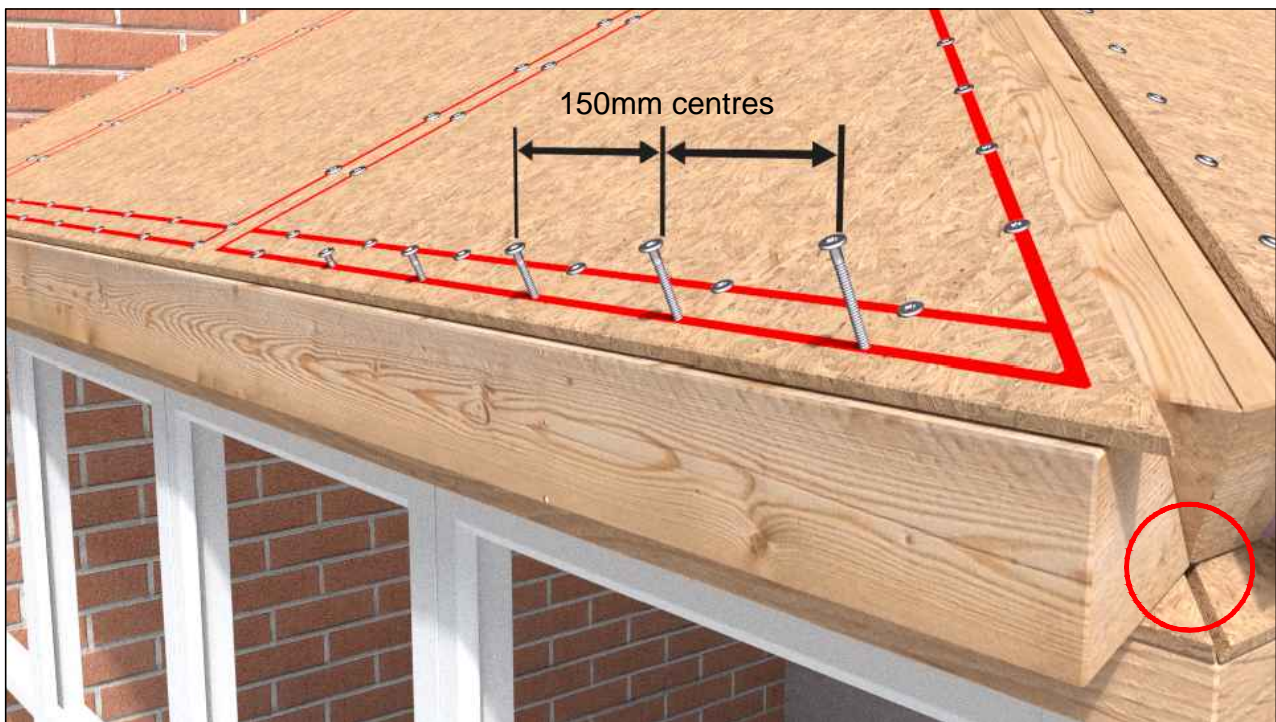
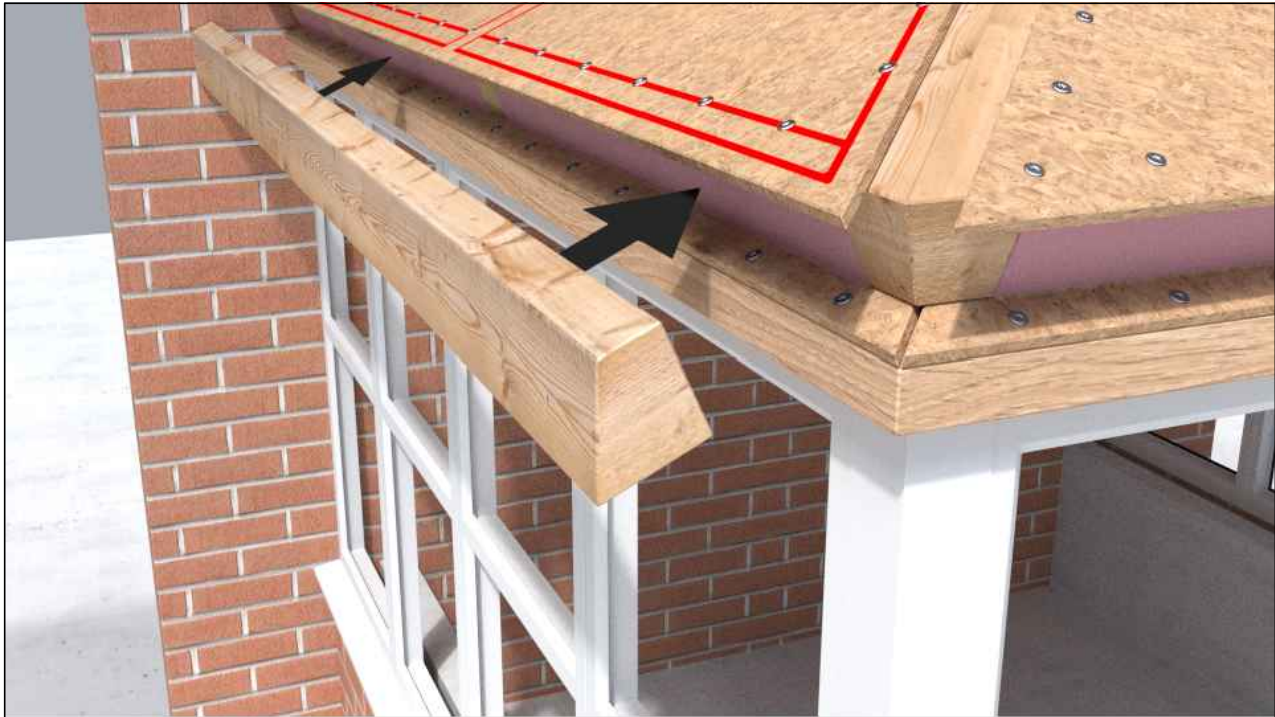

Fix using 40mm screws at approx. 150mm centres, 25mm from edge of panel. Screw through and secure into eaves beam infill section. Repeat fitting of infill timber around the entire perimeter of the roof. Ensure fillet finishes at location circled above.

180mm Fixings

Fix using 180mm screws on the 25mm and 70mm lines of each panel as shown below.
Use additional screws where panel width exceeds 592mm.

6mm x 180mm fixings (50's)
XSR-CSS6180 - 50

 Red dot denotes fixing locations below.

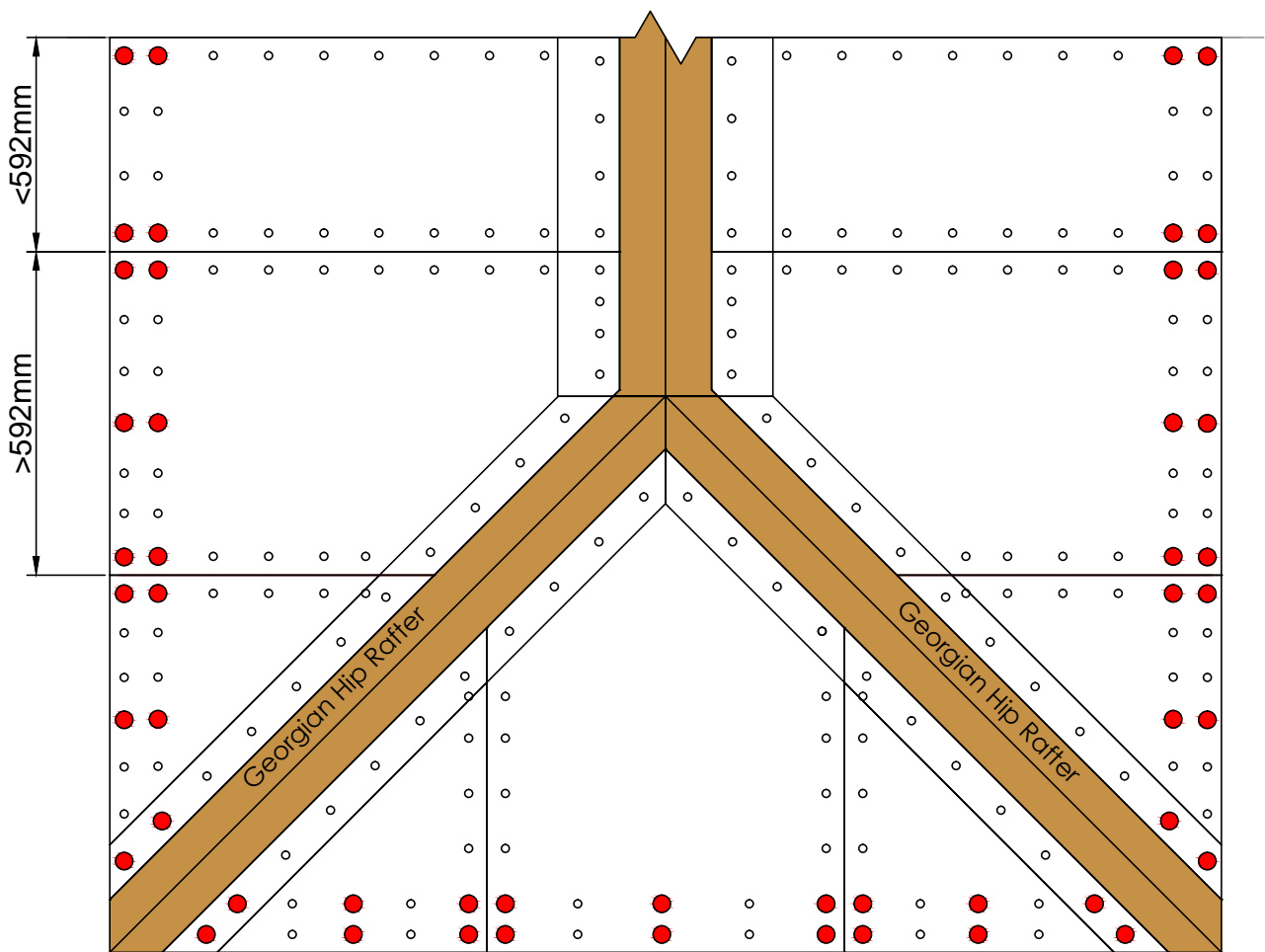
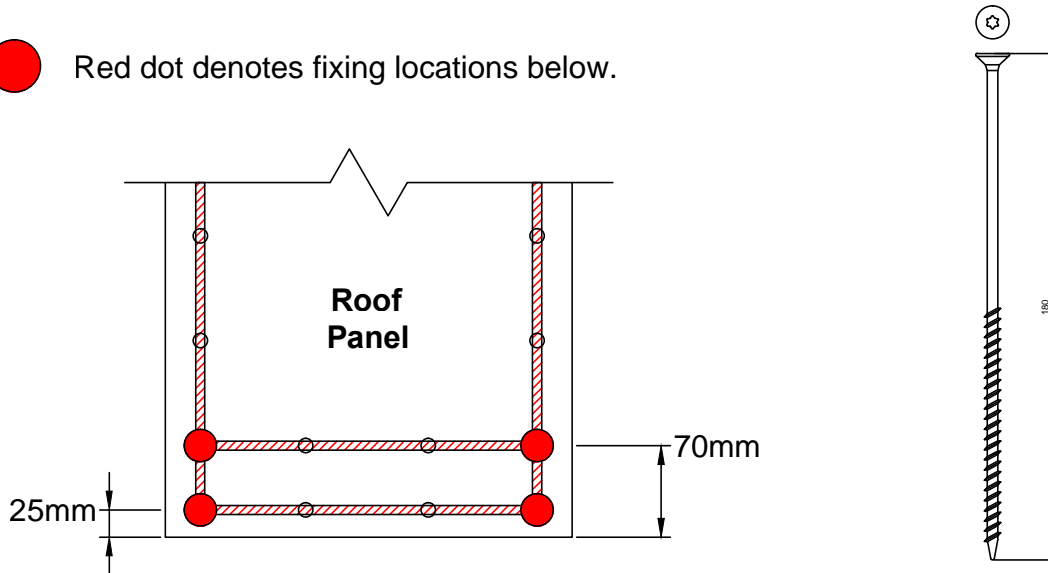

Fitting Eaves Tray

Fix eaves tray to panels using 40mm screws at regular intervals and 100mm from each end. Overlap eaves tray sections by 100mm.

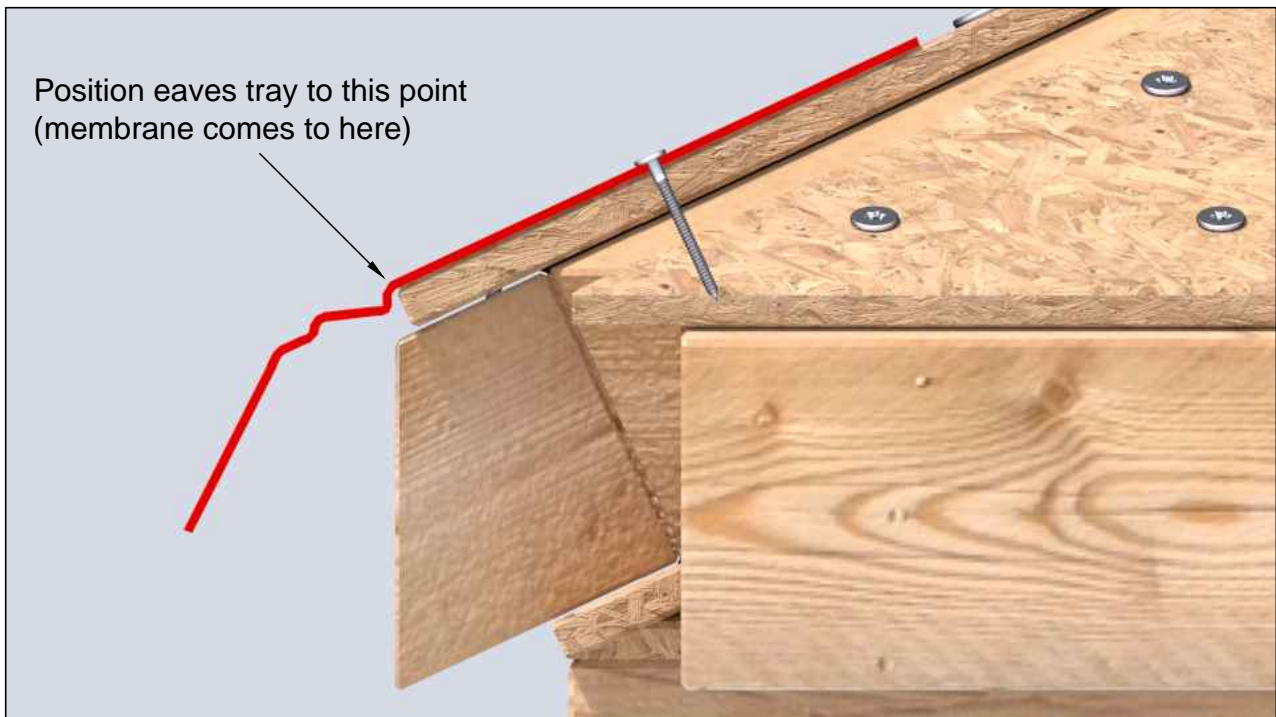

Ensure eaves tray sections overlap at joins to offer protection against water ingress.

Fitting Breather Membrane

Staple bottom layer of breather membrane to fully-pannelled roof, leaving an overlap of approx 150mm at wall end and over hips.

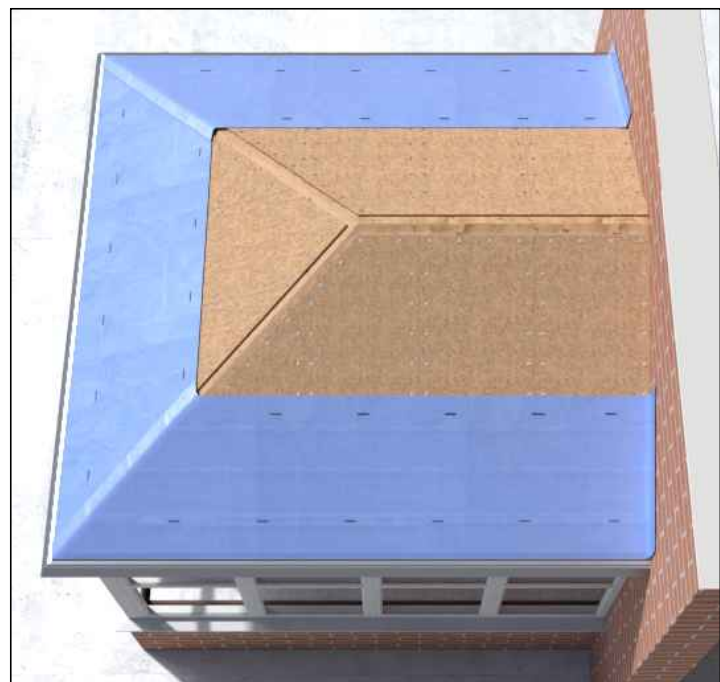
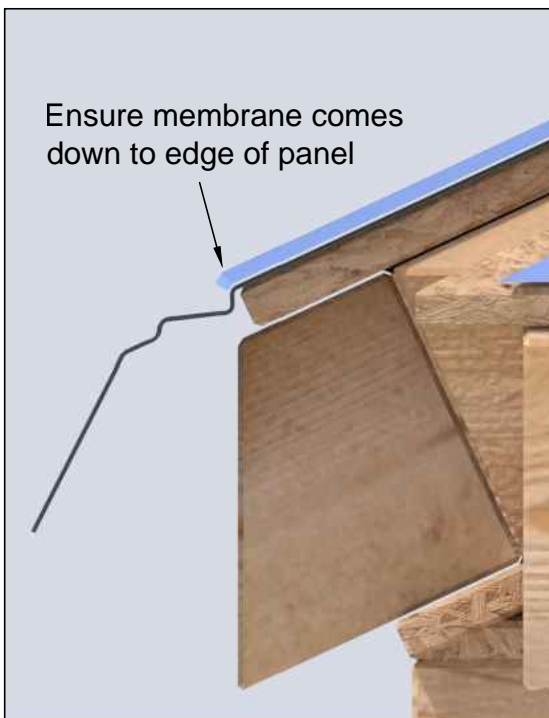

Repeat around perimeter of roof to complete the bottom membrane layer.

Fitting Breather Membrane

Staple top layer of breather membrane to the roof, leaving an overlap of approx 150mm at wall end, at hip, over ridge and over bottom section of membrane.

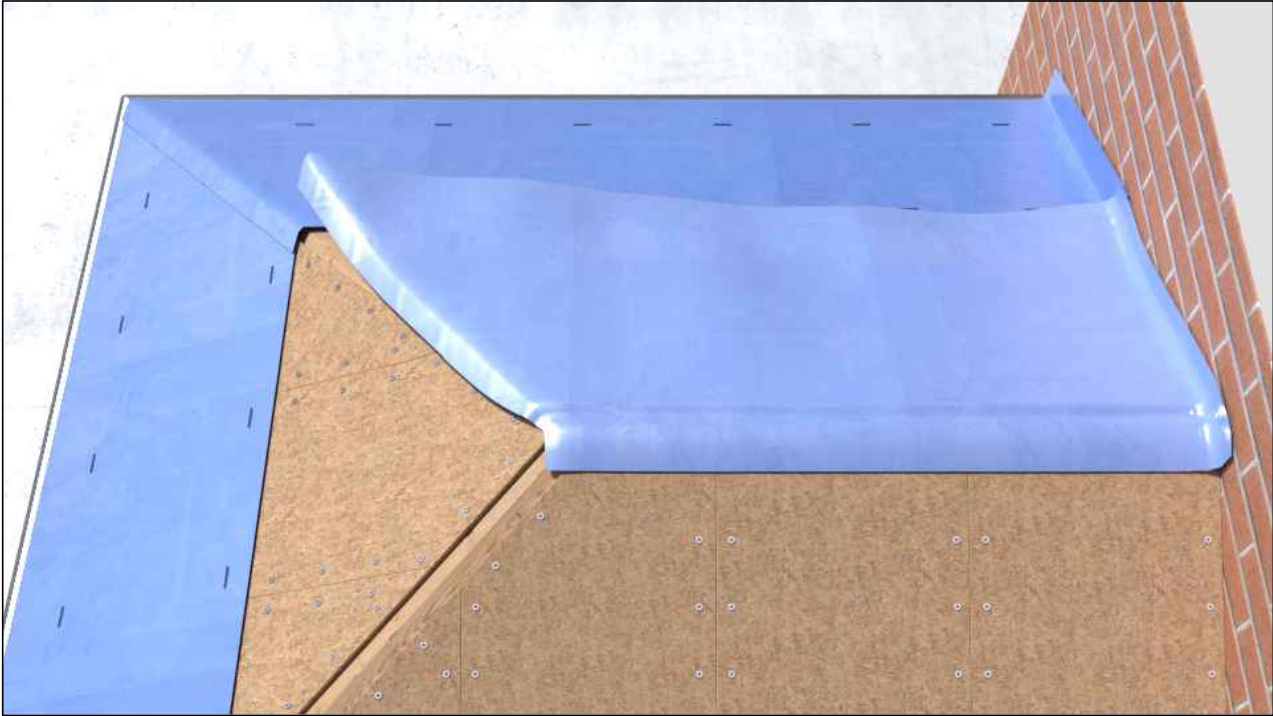

Repeat around remaining sides to complete the membrane.



Fitting Starter Soaker

Fix starter soaker over membrane at wall end, meeting at the centre line of the ridge.

NOTE: Soaker height can be reduced to suit host wall and lead height.



Fix using 40mm screws at approx 500mm centres. Cut starter soaker to 70mm from upper edge of panel as shown below.

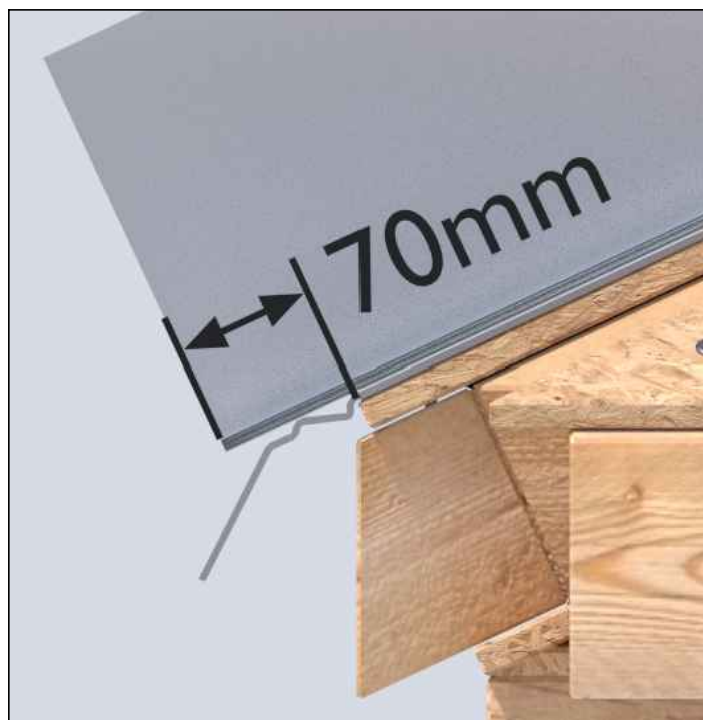

Fitting Eaves Tile Bar

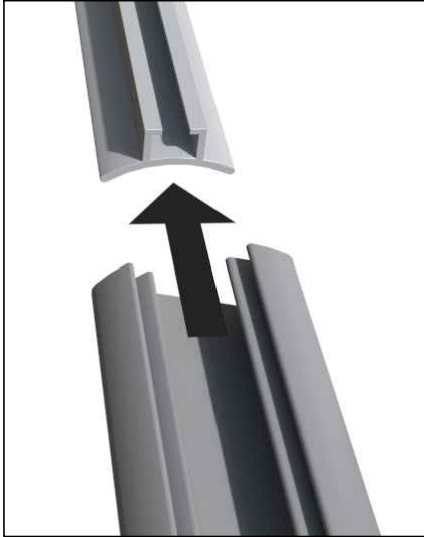

Slide out upper eaves tile bar section from lower section to allow access to fixing locations on lower bar



Fix lower tile bar section over membrane, locating up against edge of panel as shown below. Fix using 40mm screws at approx. 250mm centres.

Fix lower tile bar section up against edge of panel, and butt up to starter soaker as shown below.

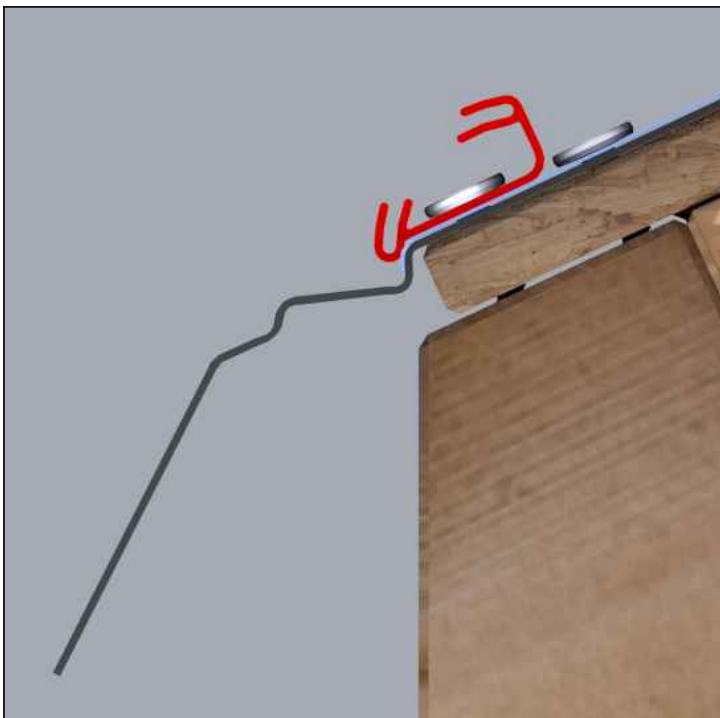

Fitting Eaves Tile Bar

Leave a gap of 10mm between tile bar sections to allow for drainage.

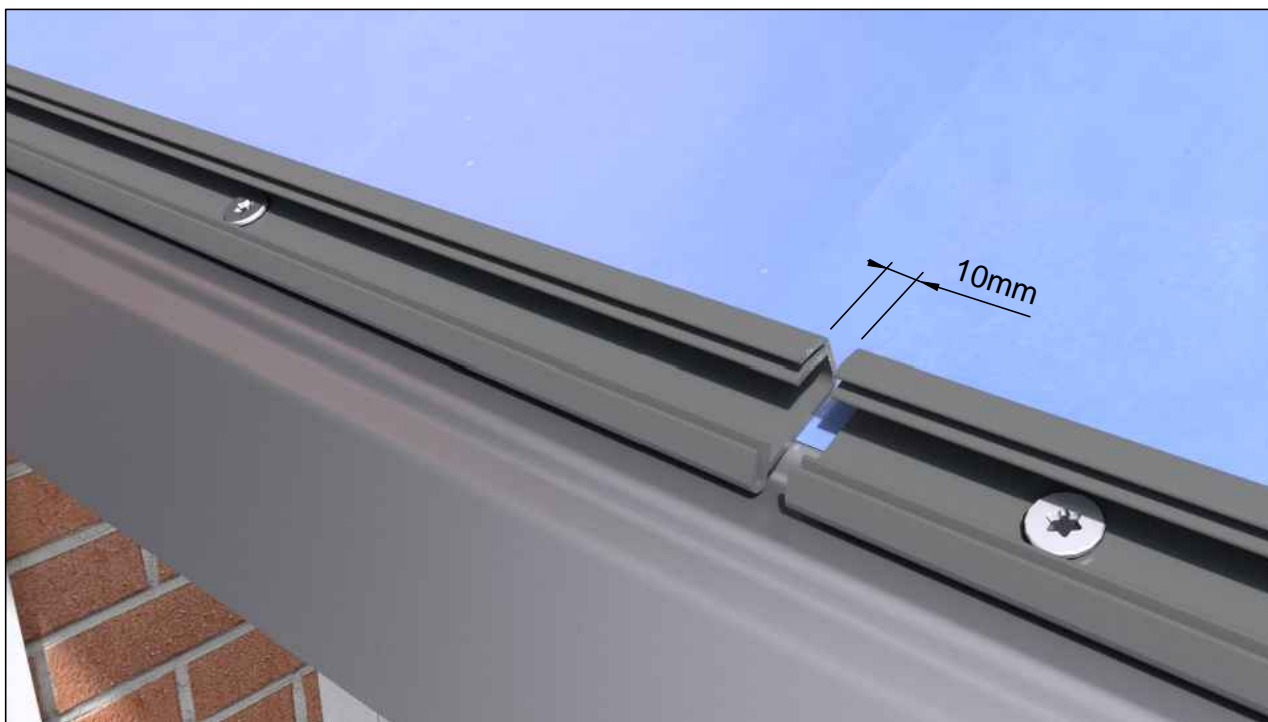

Fit upper tile bar section into lower section, leaving a 40mm clearance from the wall. Leave a 10mm gap between tile bar sections as before (these will be offset from the gaps on the lower section by the 40mm wall clearance).

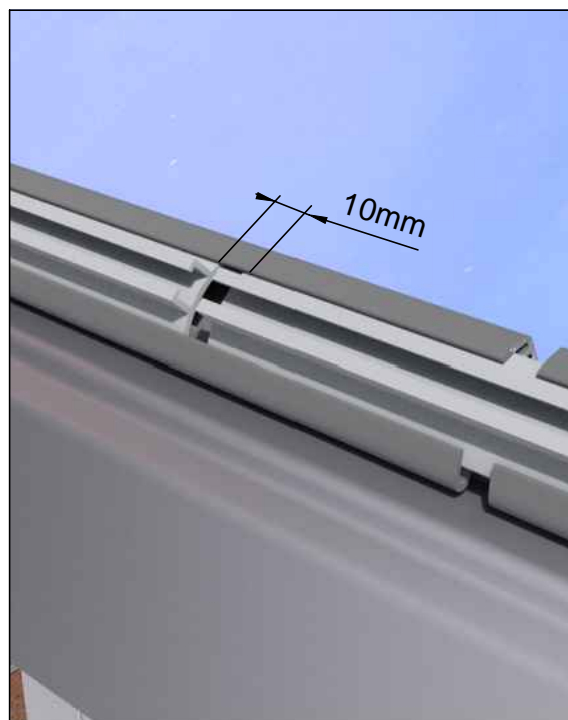
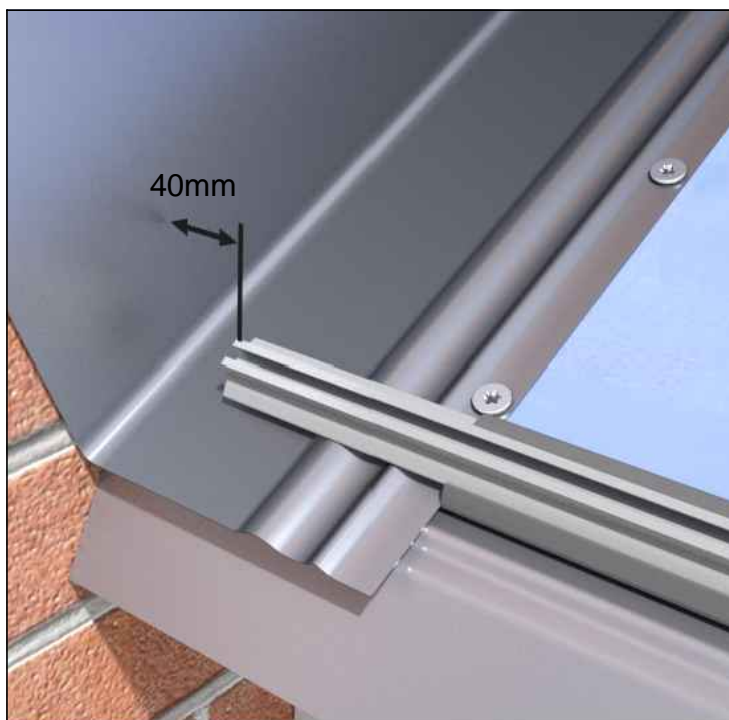

Tiling

Tabs underneath the tiles are used to locate into tile bar (shown below) and also other tiles (see next page)



Tabs locate into tile bar as shown below.



Tiling

When tiling the right elevation, the first full tile of each row requires the long tab along the right hand edge to be removed prior to fitting, as shown below.



NOTE: Refer to supplied tile layout plan for single and double tile locations.

Working in a clockwise direction around the roof, fit first tile onto tile bar and push up to wall end, leaving a gap of 40mm from wall.

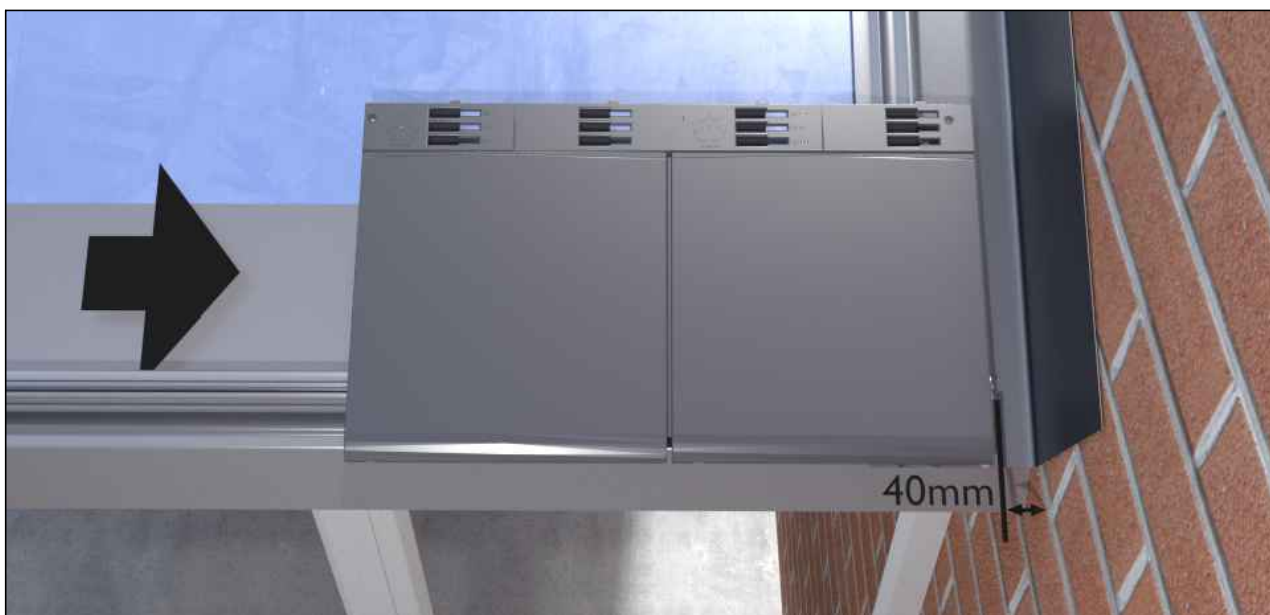

Tiling

Subsequent tiles locate into placed tiles via the long tab along the right hand edge. Insert tile so that the edge of the other tile comes up to the 5mm mark shown on the tab as shown below.



At the end of a row trim a double tile in line with the hip, removing an additional 20mm as shown.

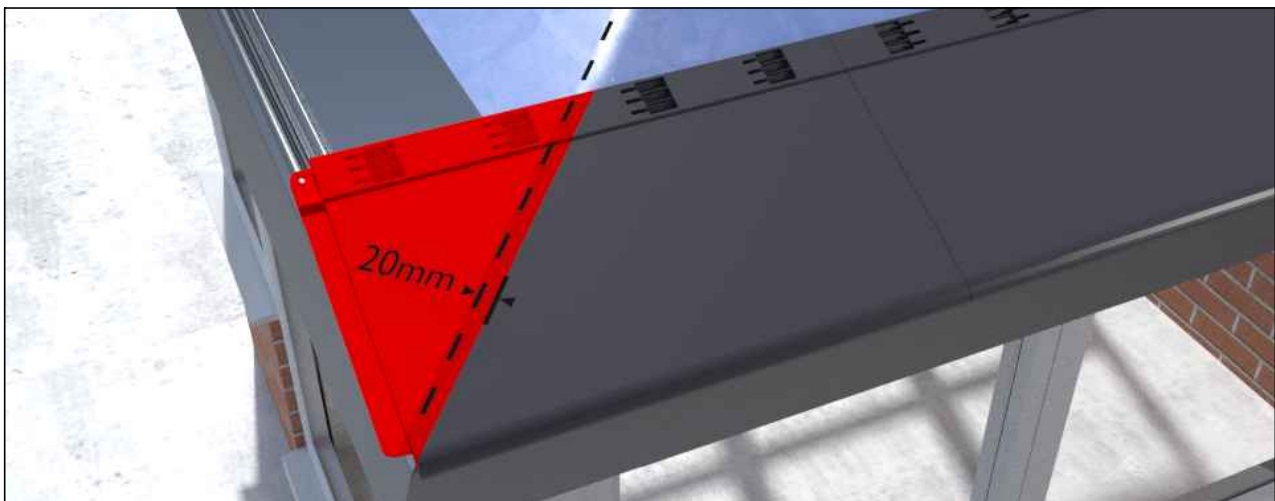

Make sure all tiles on the row are running inline, then fix with 40mm screws via the screw ports on the tiles.

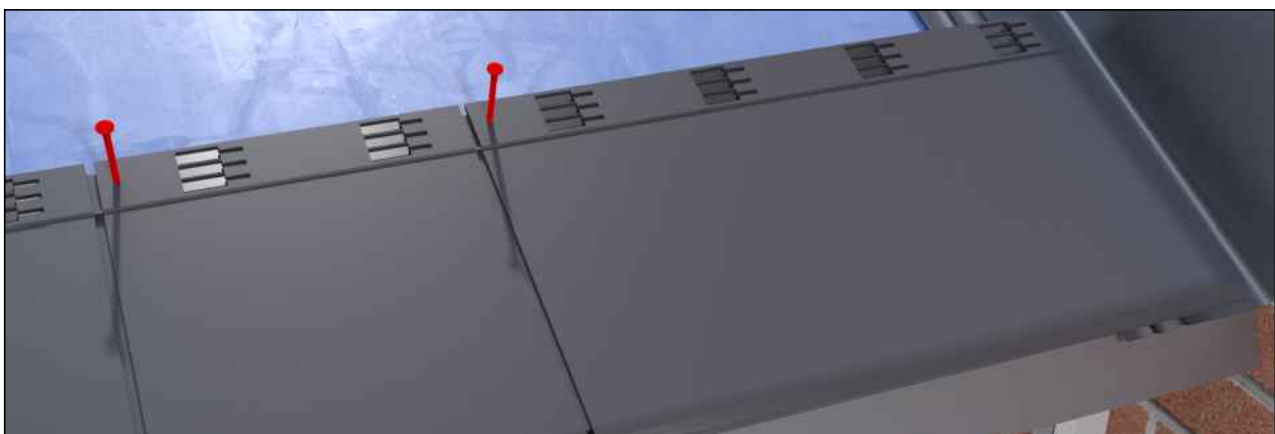

Tiling

Start next row with cut down double tile, and tile along the row as before.

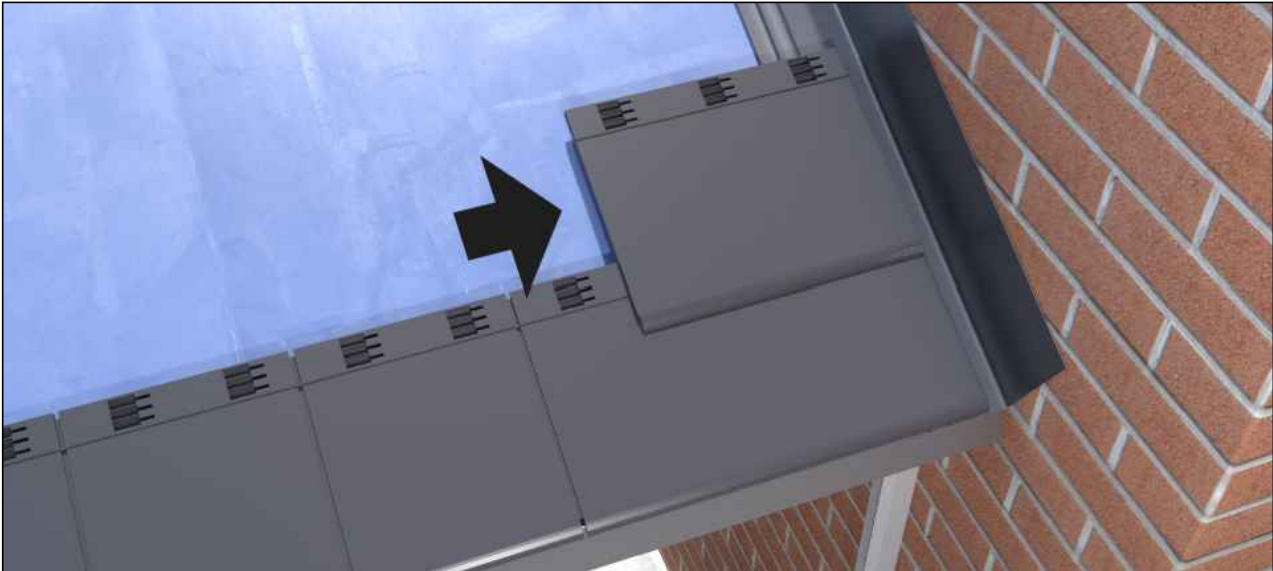

Use tabs on underside of each tile to locate the tile into tiles on the row below, sliding to the right to lock in position. The 250mm receiving slot is used in all cases.

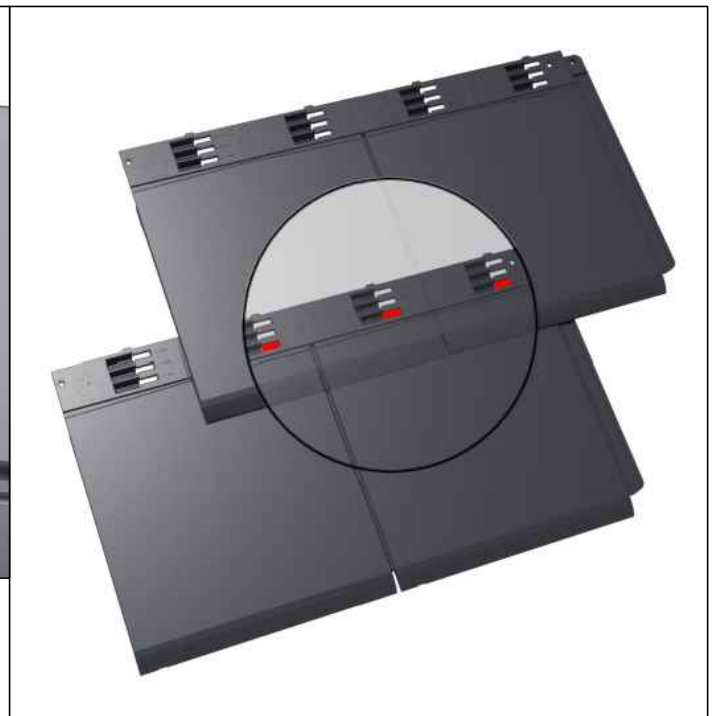

Tiling

Complete higher rows in the same way, trimming at the hips as per previous instructions.



Tiling

Tiling proceeds in a clockwise direction around the roof

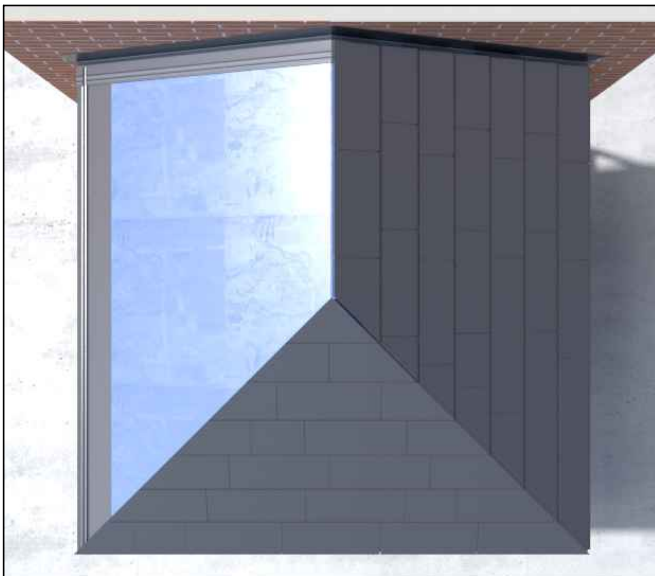
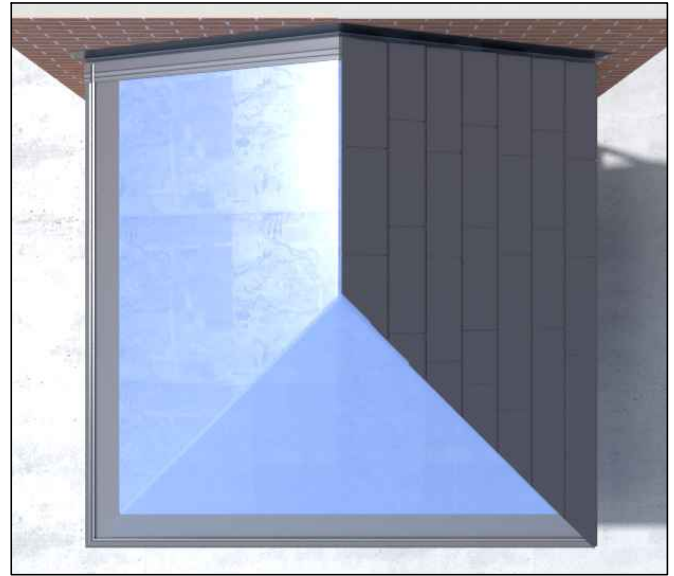
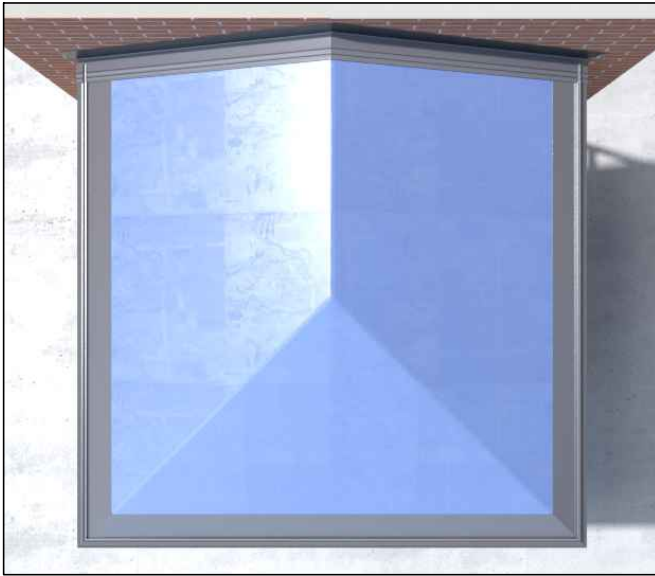

Tiling

At the front end of the roof, begin with the first tile of the bottom row in the centre and tile outwards to the hips.

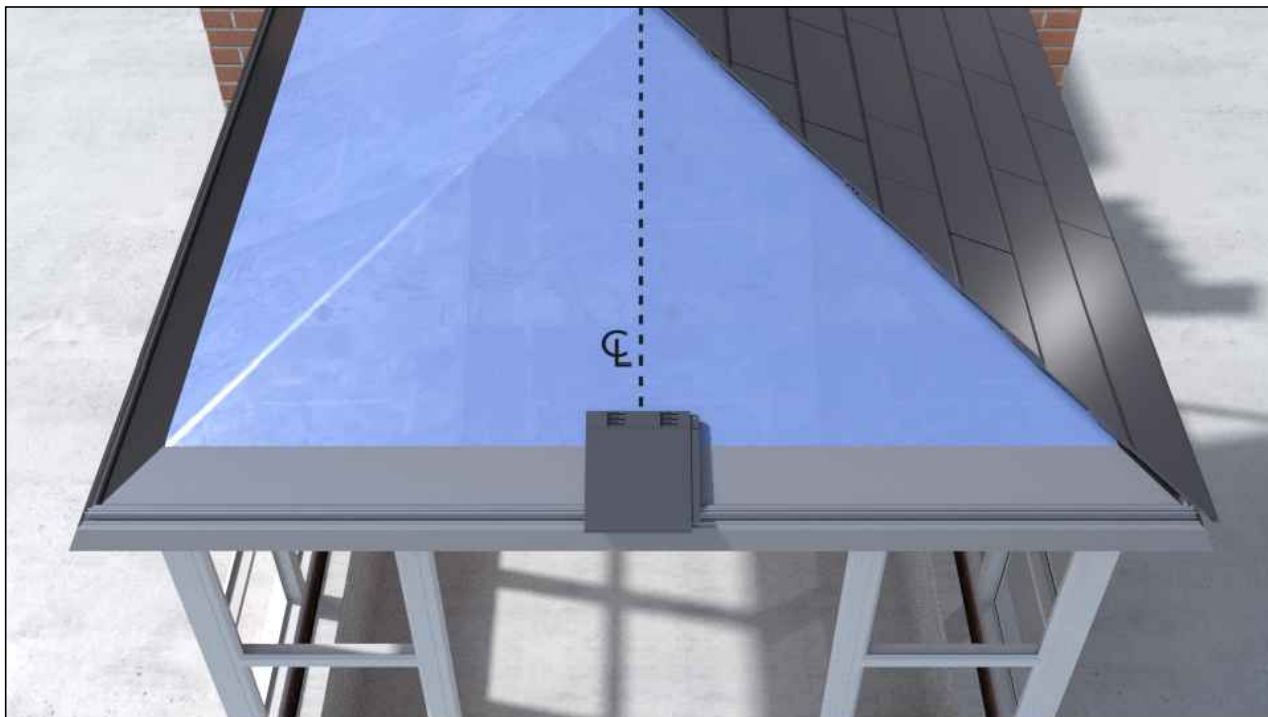

Tiling

For all rows above the bottom row, tile each row from left to right as before, and build up to the apex.

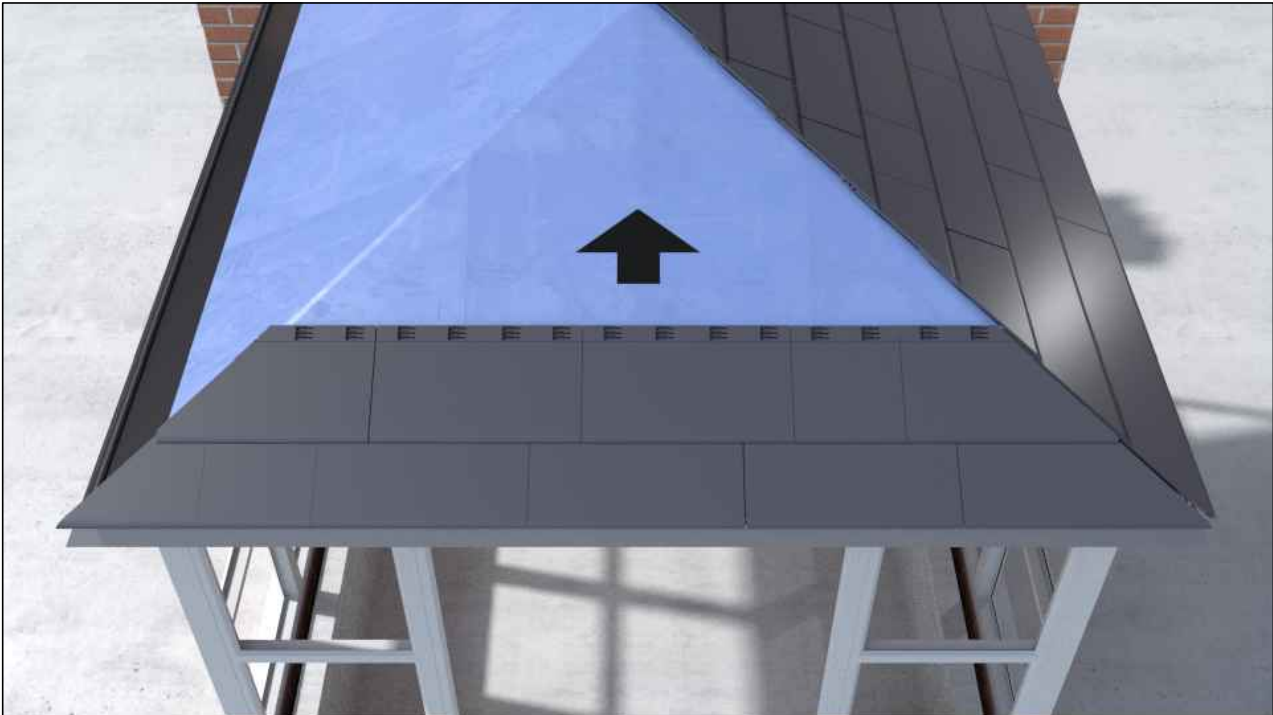

Tile the remaining side to complete the roof.



Hip Caps

Join each hip end cap to a section of hip cap and run 20mm x 25mm expanding foam along the underside of each edge as shown below. Leave 30mm from the male end.

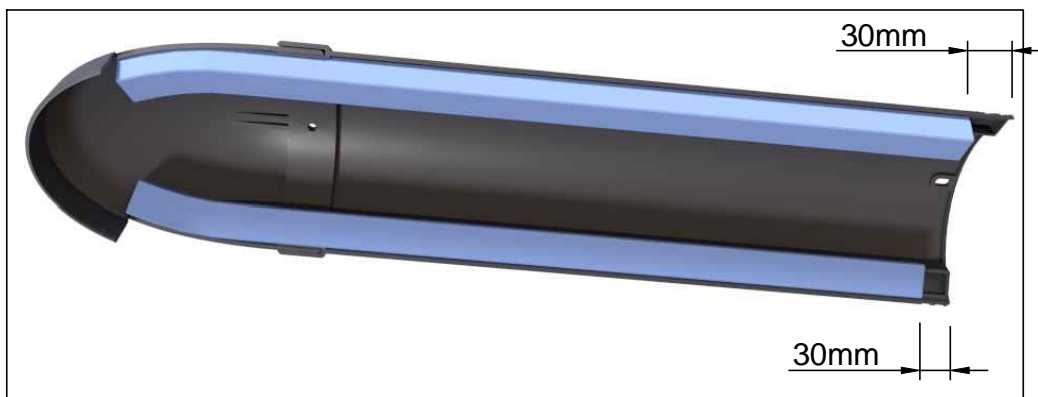

On the other hip caps leave the same 30mm from the male end, but extend the expanding foam 30mm past the female connector end as shown below.



Fit the hip end caps and first hip cap, fixing in place using 140mm fixing screws. Fit XSRCC1 screw caps over the screws.



Hip Caps

Fit the next hip cap, slotting the extended 30mm of foam tape into the 30mm gap of the previous hip cap each time. Fix hip caps using 140mm screws and XSRCC1 screw caps.

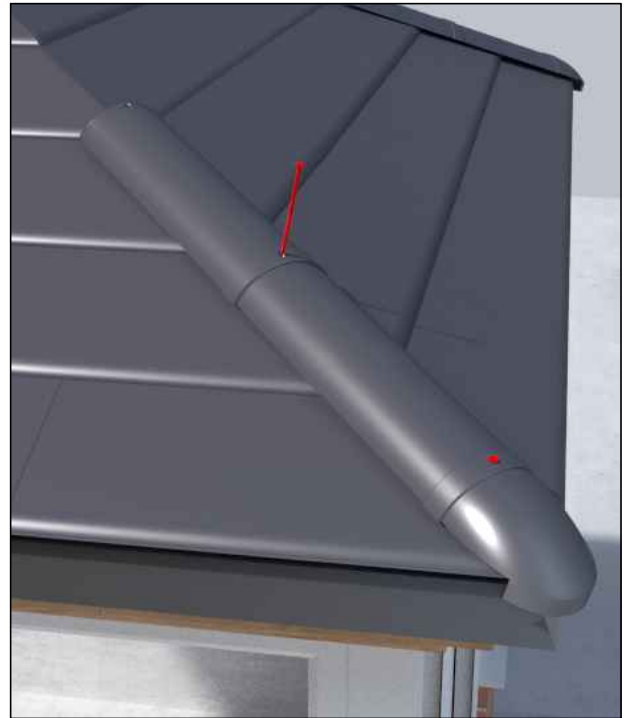
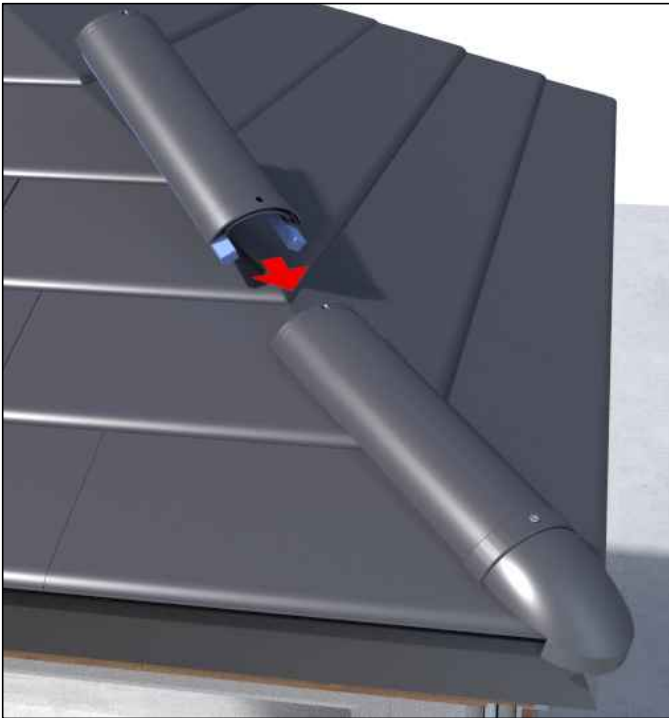

Trim hip caps in line with ridge centreline if necessary.

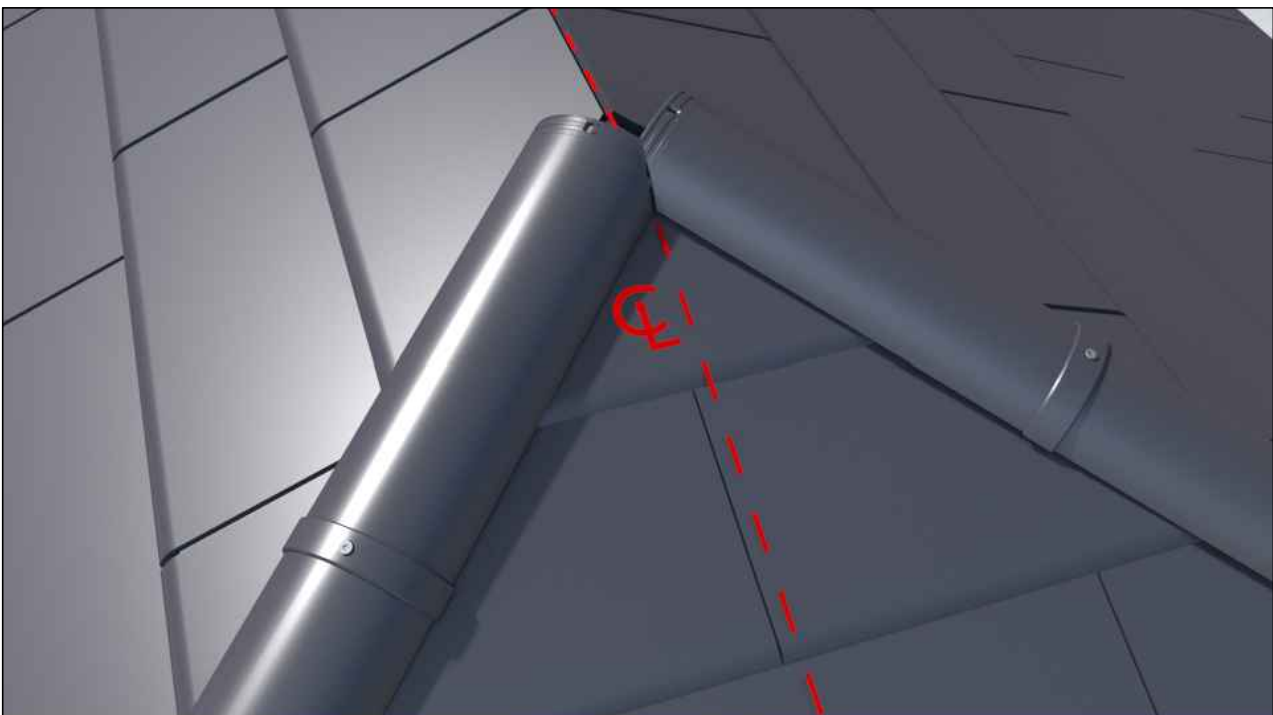

Ridge Caps

Assemble ridge cap with ridge to apex cover and make a 5mm pilot hole in both sides as shown. Fix together using an XREC3 push rivet in each side.



Place assembled ridge cap and ridge over hip tiles. Do not fix at this point.

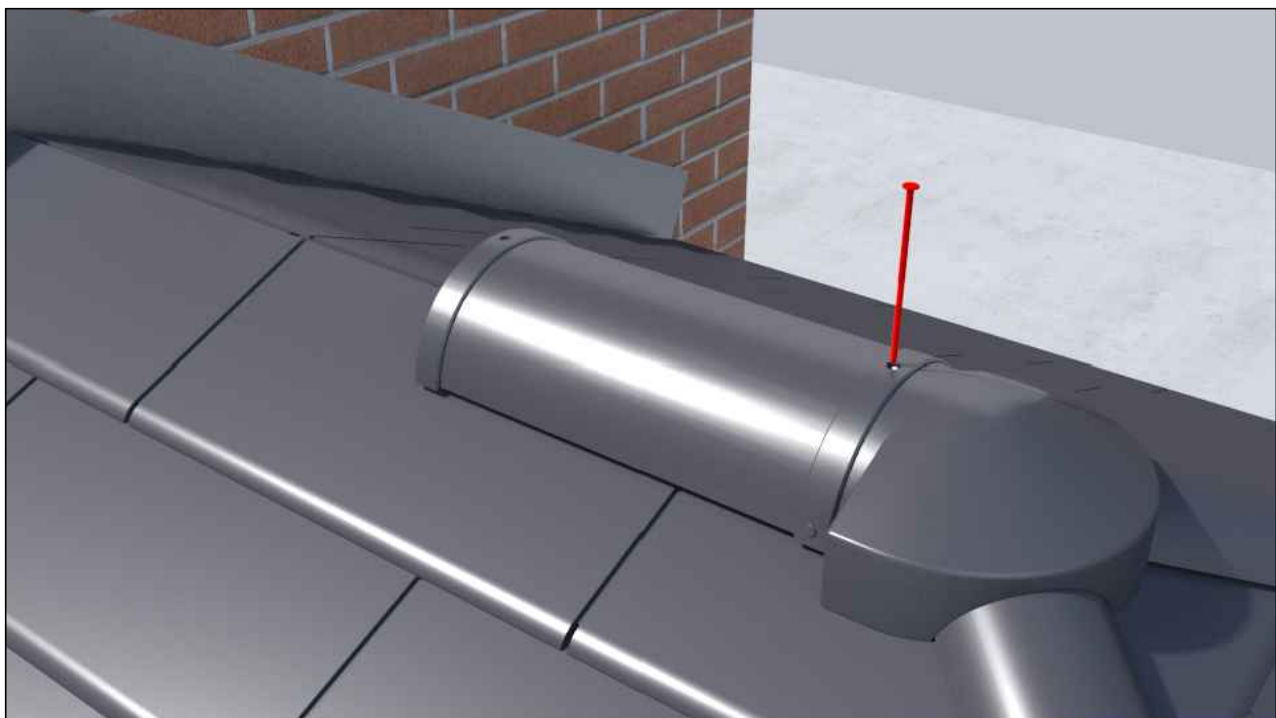

Ridge Caps

Dry fit other ridge caps using to complete the ridge back to the wall. If the last ridge cap requires cutting to the host wall, place the female connecting collar up to the wall and trim from the male end. Then dry fit this last ridge cap, running a pilot hole through the connection. Once all caps are placed, fix using 140mm screws and cap the screws with XSRCC1 screw caps. To complete the assembly seal the last ridge tile to the host wall.

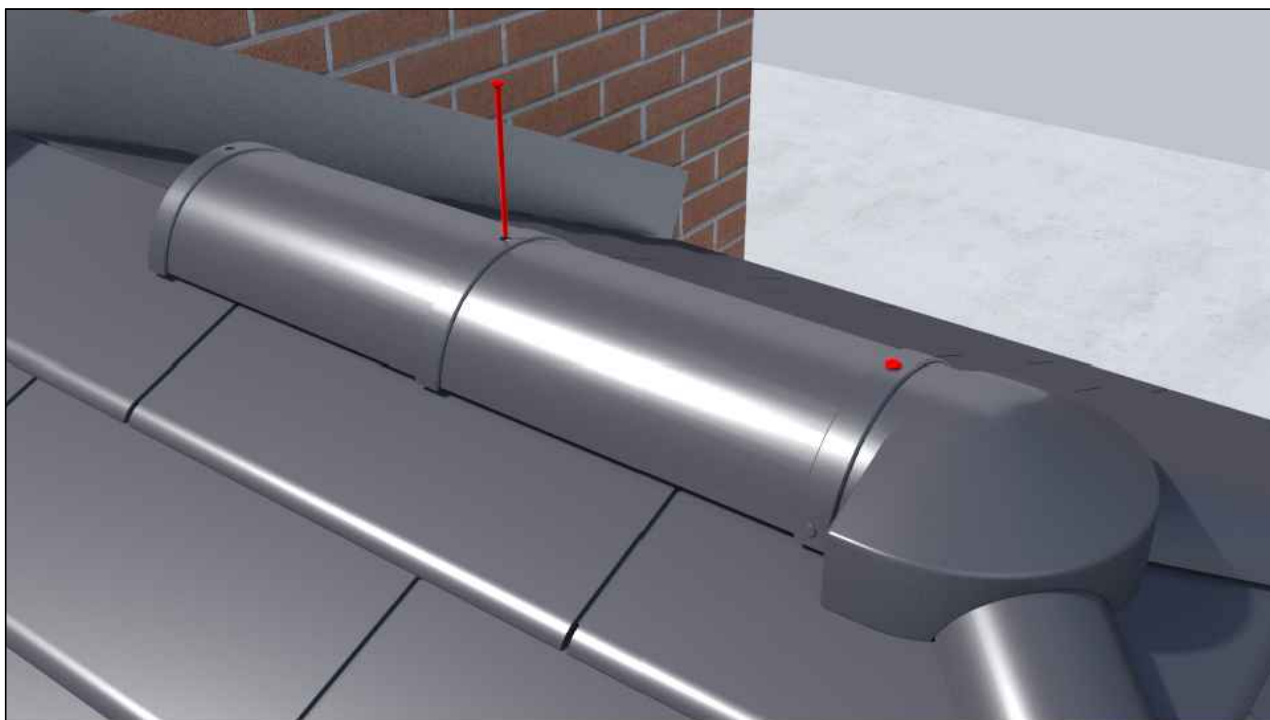

NOTE: Double-hip designs will require the middle ridge cap to have the female connector removed to allow it to connect to both neighbouring ridge caps.

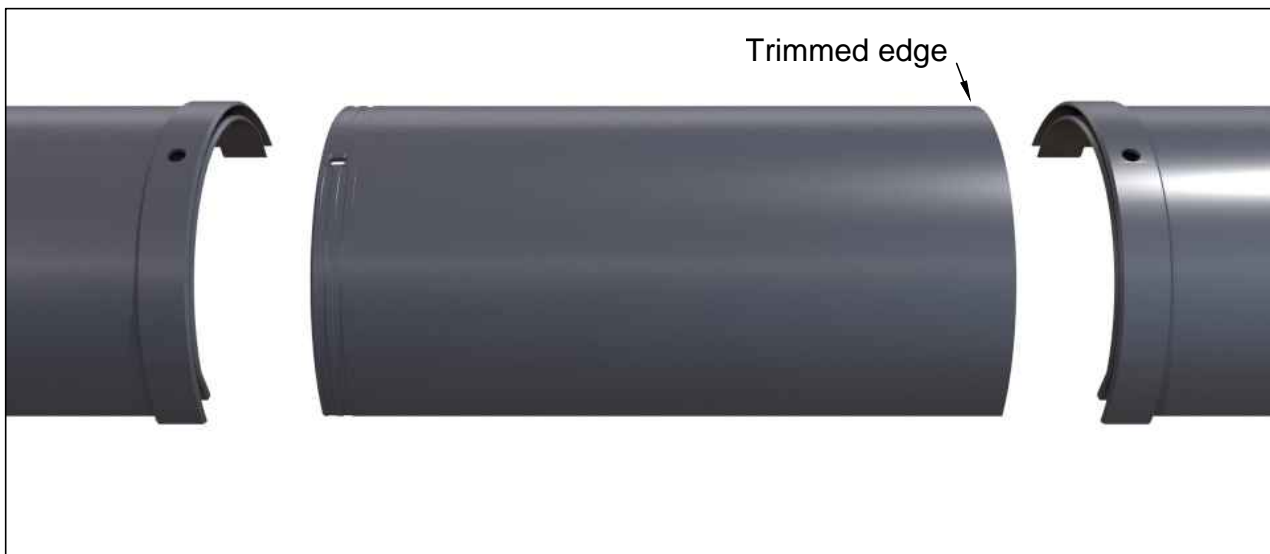

Fascia Board

Fix fascia board J-clip to eaves beam timber using 40mm screws at approx 500mm centres. Please note that black/foiled profile will need fixing at 300mm centres.



Ensure lower fascia board section is cut to soffit depth X shown below. Mitre ends to suit design.



Repeat this step on all elevations.

Fascia Board

Before fitting the fascia boards it may be necessary to reduce the height measurement X shown below to ensure the fascia boards fit correctly.

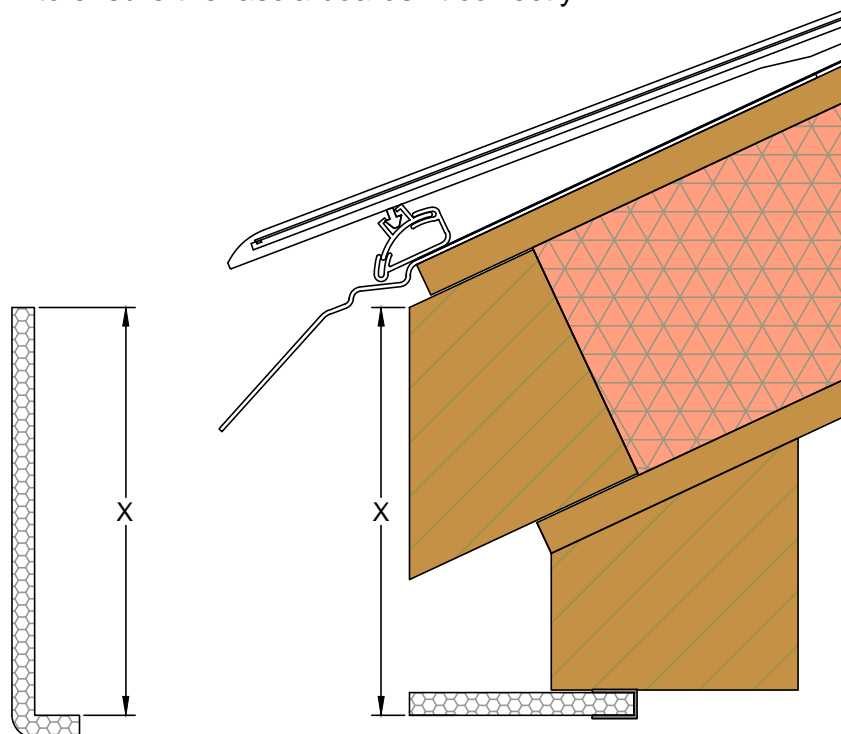

Fit upper fascia board section and fix in place using polypins at max 500mm centres. Please note that black/foiled profile will need fixing at 300mm centres. Ensure polypins locate into eaves infill timber.



Repeat this step on all elevations.

Fascia Board

Repeat process around perimeter of roof.



Fit corner mouldings to fascia corners to finish off fascia board.



Tie Wires

OPTION 1 - Adjustable Bracket (Without Pelmet)



Drill pilot holes at the locations shown for the tie wire bracket. Ensure the holes fall either side of a panel joint (dotted line below). The tie wire position will be indicated on roof plan.

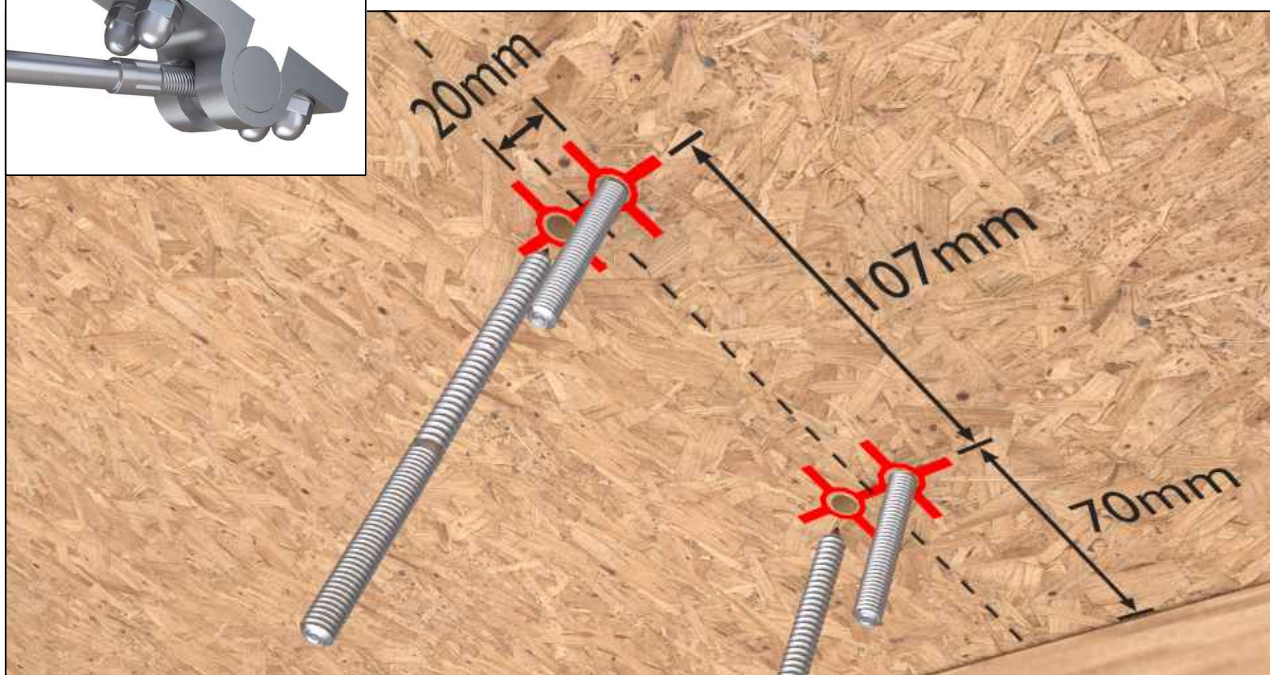

Fix dowel screws into the pilot holes. Fit nylon sleeves over each dowel screw and fix assembled tie wire bracket onto screws using 4x washers and nuts. Please refer to the supplied fitting instructions found within the tie wire box.

NOTE: Use the supplied Nylon sleeves or alternatively use a timber packer to suit required plasterboard depth. On roofs that use insulated plasterboard use a timber packer to suit plasterboard depth making sure the timber packer is securely fastened through to the solid timber connecting rafter.

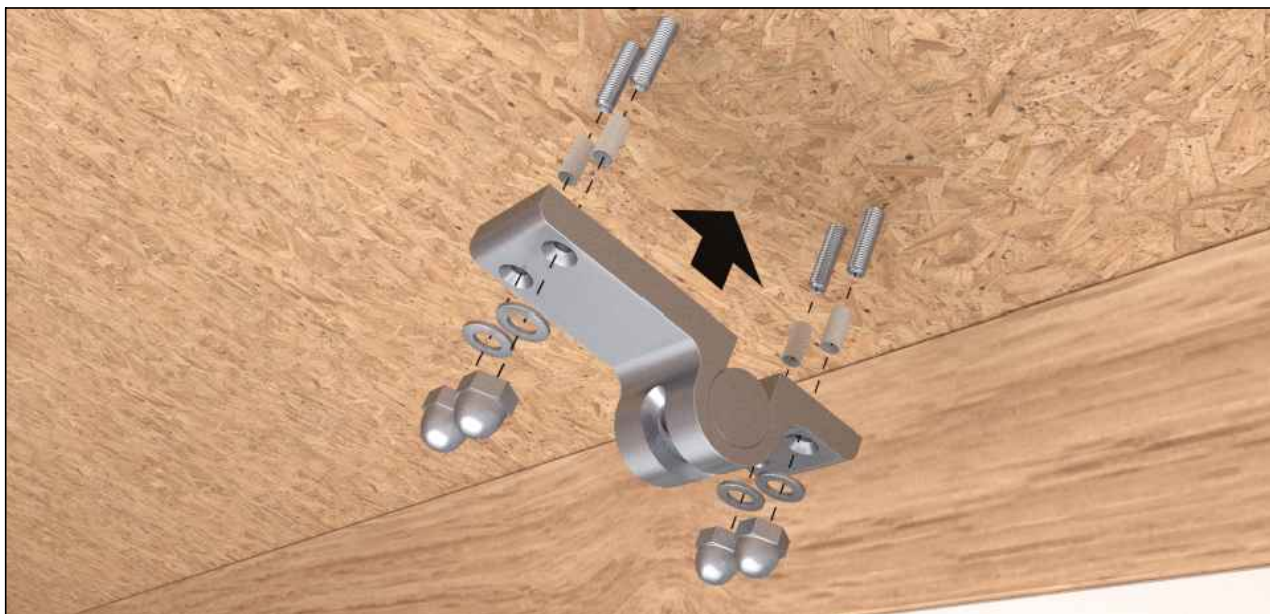

Tie Wires

Fit tie wire into brackets following standard procedure. Please refer to the supplied fitting instructions found within the tie wire box.



12mm plaster board and skim will leave the fixing bracket level with the plaster.



Tie Wires

OPTION 2 - Fixed Bracket (With Pelmet)



Drill pilot holes at the locations shown for the tie wire bracket. Ensure the holes fall either side of a panel joint (dotted line below). The tie wire position will be indicated on roof plan.

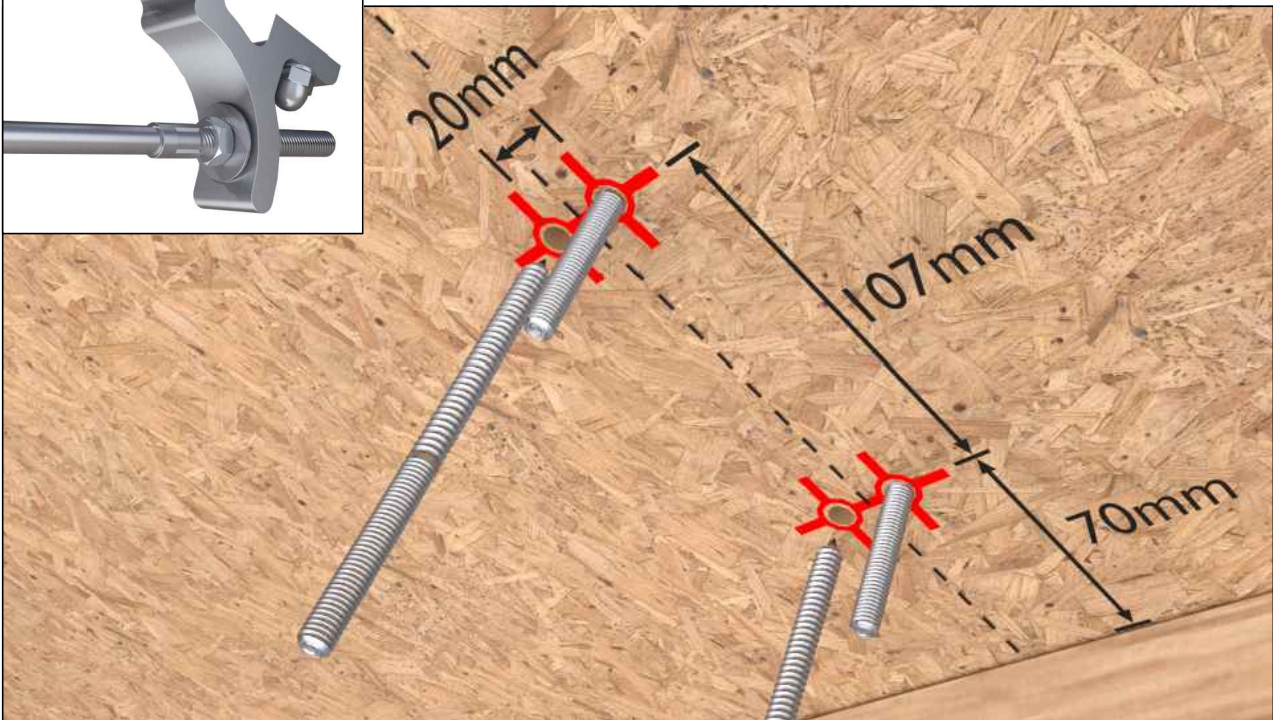

Fix dowel screws into the pilot holes. Fix tie wire bracket onto screws using 4x washers and nuts. Please refer to the supplied fitting instructions found within the tie wire box.



Tie Wires

Fit tie wire into brackets following standard procedure. Please refer to the supplied fitting instructions found within the tie wire box.



VELUX Window

Fix timber into panel as shown

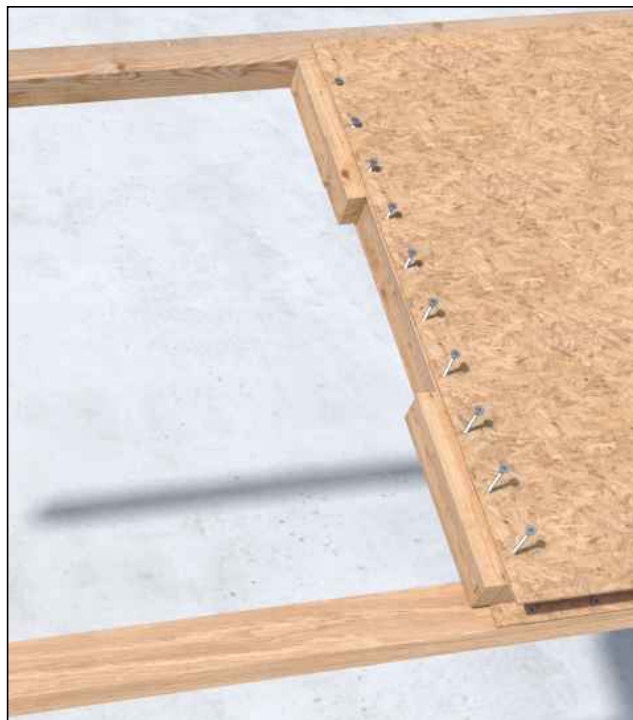
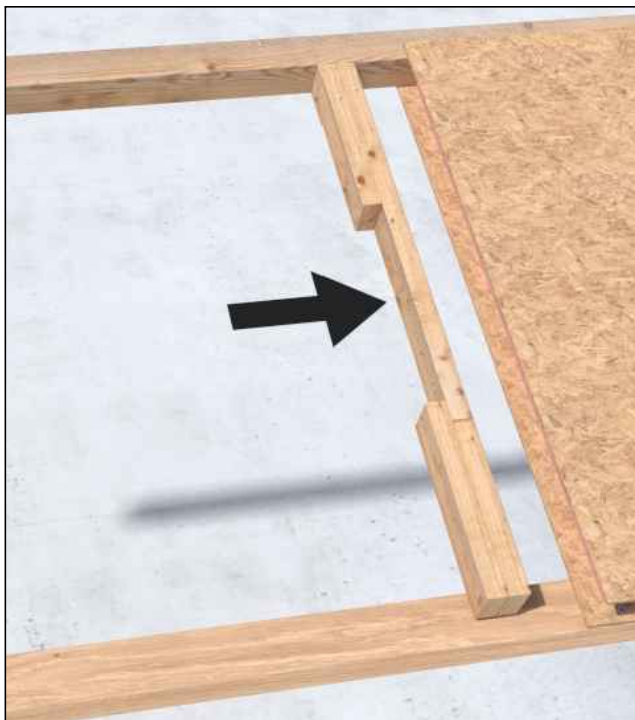

Fix small panels to ridge and eaves timbers using 40mm screws at 150mm centres. Repeat on underside of panel.

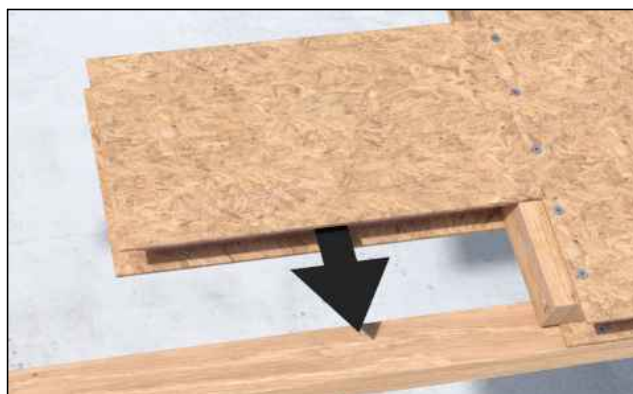

VELUX Window

Fix timber into panel as shown

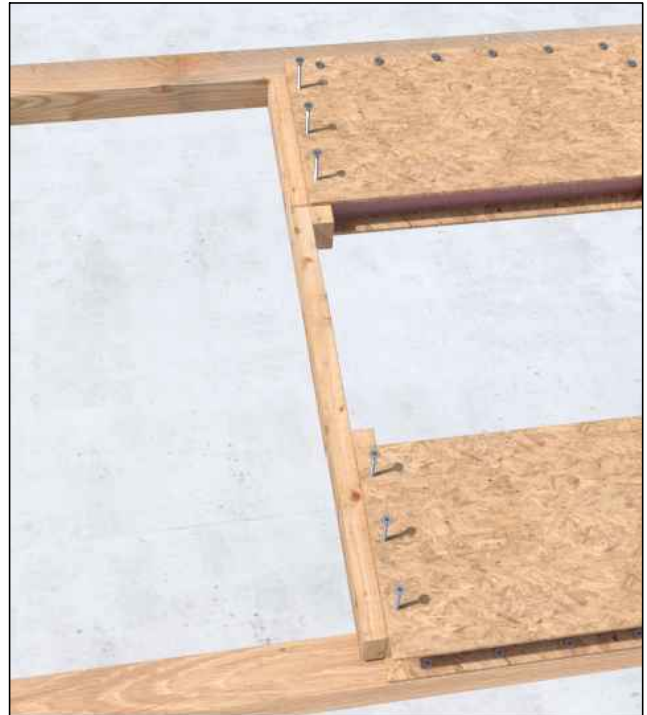
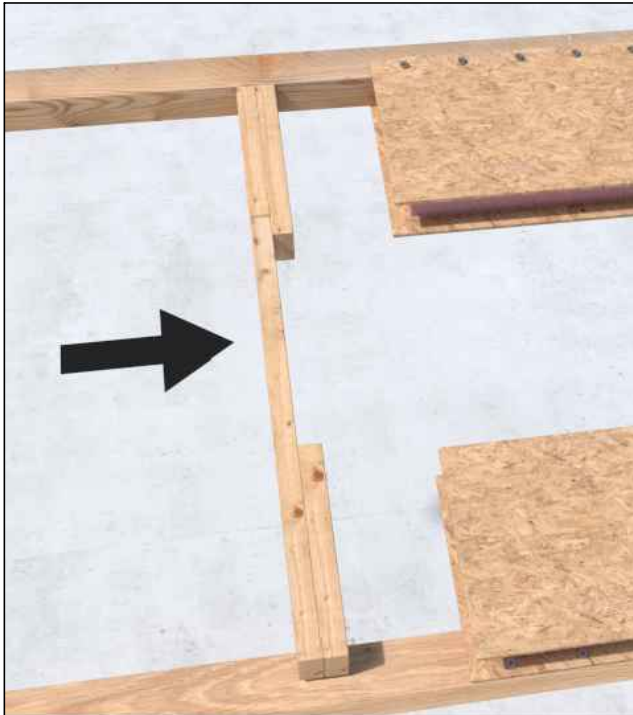

Fix small panels to ridge and eaves timbers using 40mm screws at 150mm centres. Repeat on underside of panel

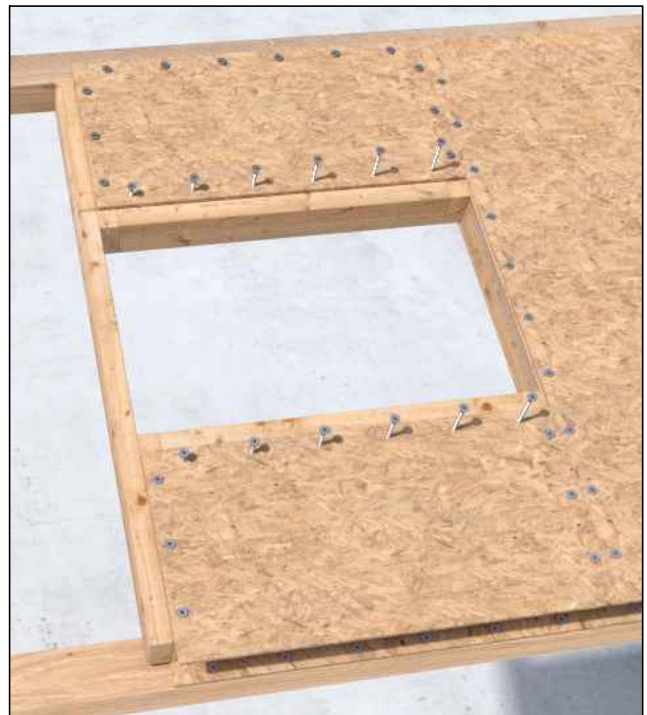

VELUX Window

Fix timber into panel as shown

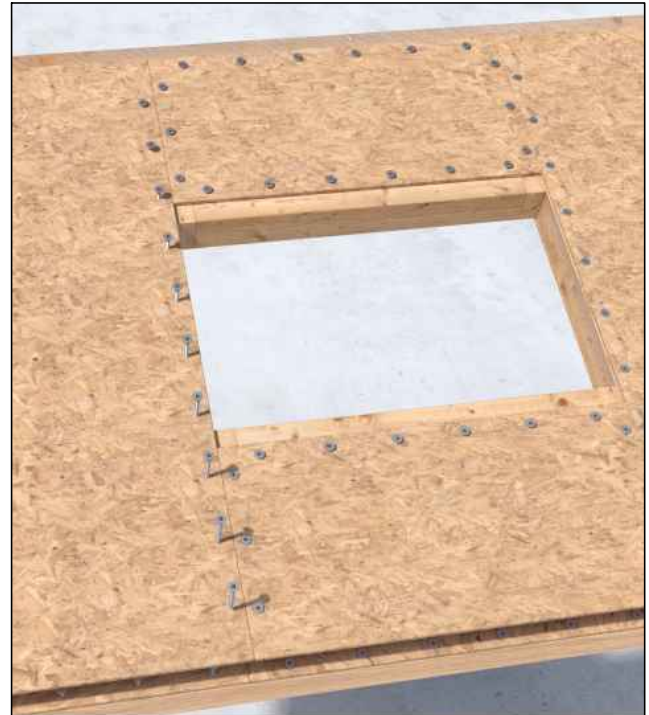
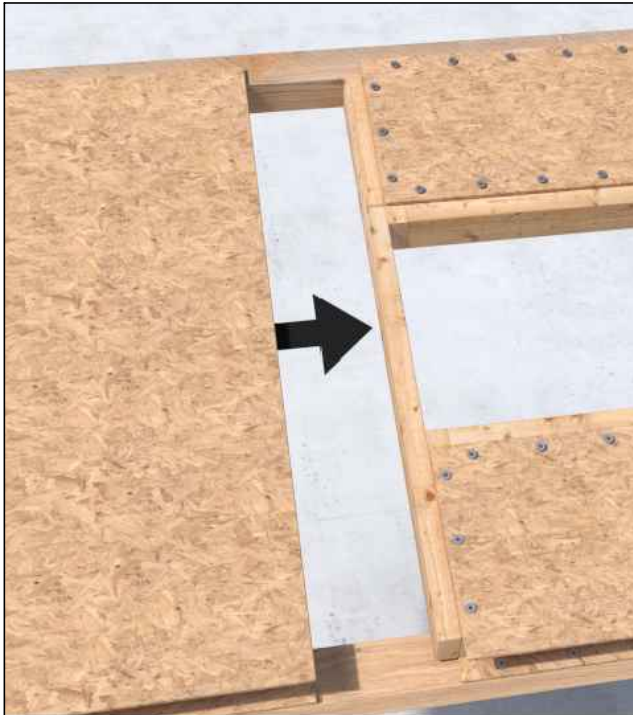

Fix small panels to ridge and eaves timbers using 40mm screws at 150mm centres. Repeat on underside of panel. Please refer to the VELUX fitting instructions found within the VELUX Flashing and Window boxes.



Gable End

Where a gable end is required, the eaves beam timber will project 150mm from the front of the frames as shown and the panel will end flush with the end of the timber, secured using 40mm screws as before.

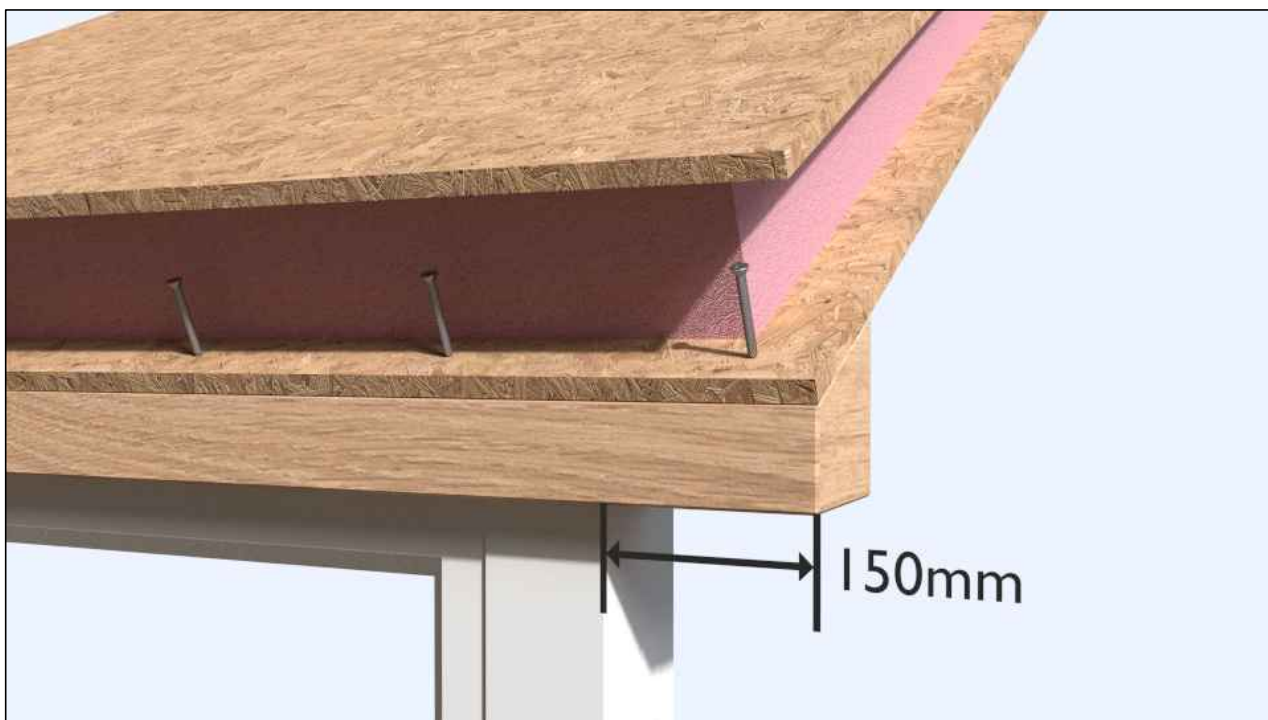

Fit gable infill into end panel and fix using 40mm screws on top and bottom face as shown below.

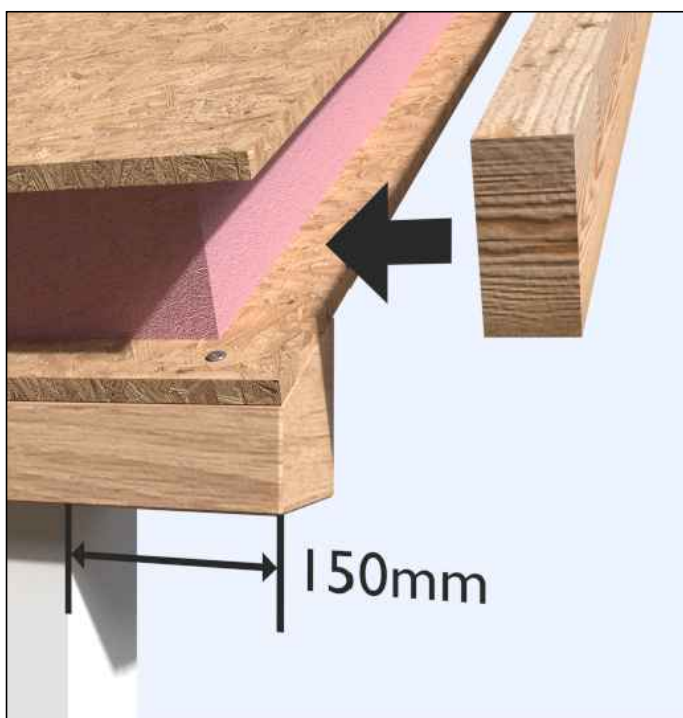

Gable End

Fit infill timber as per standard instructions (see page 20).



Fix using 40mm screws at approx 150mm centres.



Gable End

Fit dry verge into space between panel and roof tiles. rimming may be required at the areas shown in red below.



Fix dry verge to gable end infill timber using 40mm screws at 500mm centres, and max 150mm from each end.



Gable End

Fix fascia board J-clip to eaves beam timber using 40mm screws at approx 150mm centres.



Fit lower fascia board section into fascia clip.



Gable End

Fit upper fascia board section to side and front sections and fix in place using polypins as previously illustrated.



Gable End

Repeat process for front of gable end, butting fascia J-clip up to front face of frames.



Fit lower fascia board section into fascia clip.



Gable End

Fit upper fascia board section so that it butts up to corner fascia board section and sits up to centreline of roof.



Fix in place using polypins at approx 150mm centres.



Gable End

Fit fascia board to inner face of gable end rebate as shown below. Corner of board must be locally removed to allow it to sit up to existing board.



Fix in place using polypins.



Gable End

Fix corner mouldings to cloak off corners of fascia board.



Repeat process on other side of roof.



Gable End

Fix gable end cap at end of ridge

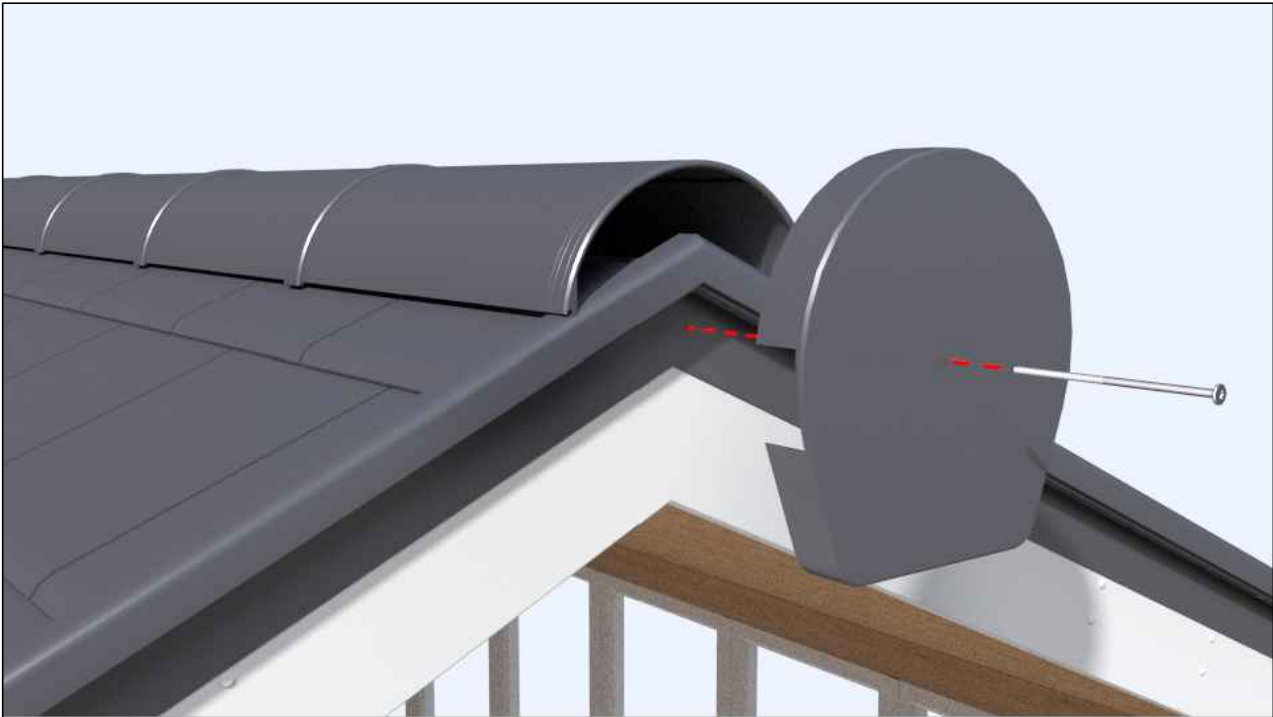

Gutter

Screw aluminium gutter clips to fascia using supplied 40mm screws at approx 150mm from corners and at 500mm centres in between. Locate gutter brackets into clips and lock into place as shown below.

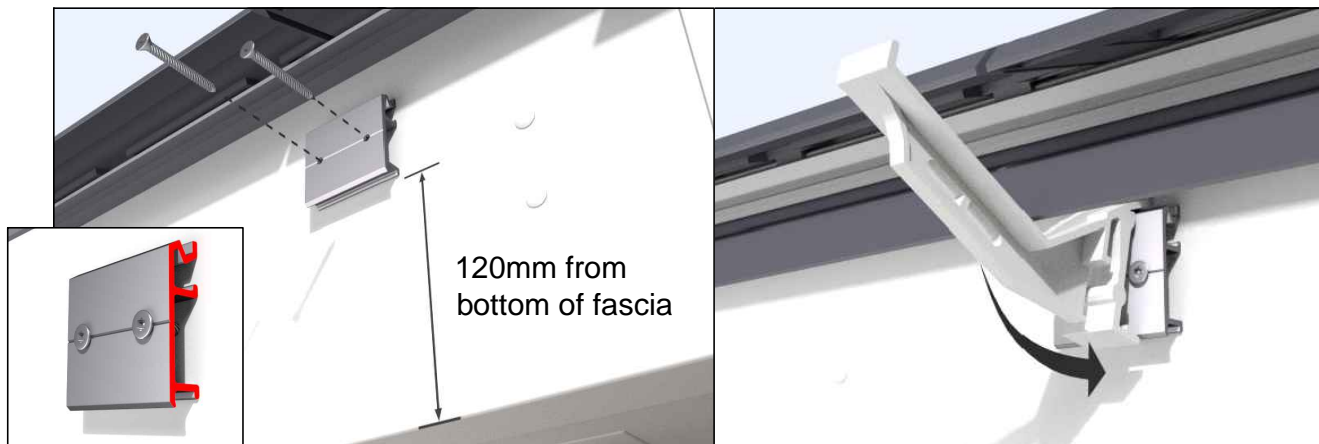

Locate front of gutter into bracket at location X shown below, then swing and clip the gutter into place, making sure it securely clips into the back of the gutter bracket.

Fit remaining clips, brackets and gutter sections to suit style of roof, and fit unions and stop ends to complete gutter.

